

CATÁLOGO COMERCIAL

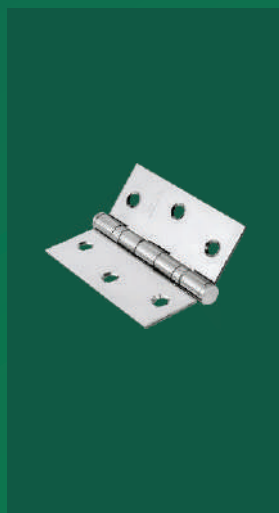

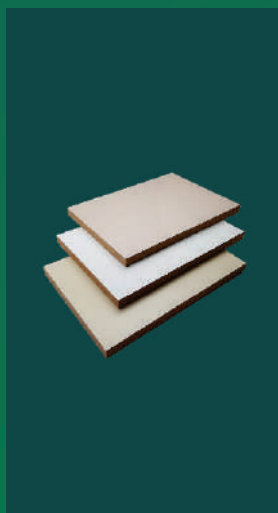

Matriz | Farroupilha - RS

Nosso maior orgulho é fazer parte da vida de milhares de pessoas em todo o Brasil e ao redor do mundo, através dos nossos produtos. Nascemos como uma pequena revenda de ferragens e hoje somos o maior fabricante de acessórios para móveis do Brasil, com cerca de 2.000 funcionários, e uma área construída de aproximadamente 100.000m².

Além do setor moveleiro, atendemos também os setores de construção civil, linha branca, metal-mecânico, alimentício e supermercadista, no Brasil e na América Latina. Somos detentores das marcas Bigfer Acessórios para Móveis, Hettich do Brasil, Contatto Puxadores e Lema Embalagens. Nossa matriz encontra-se na cidade de Farroupilha - RS, com filiais em Curitiba - SC, Curitiba - PR e Votuporanga - SP.

BIGFER
acessórios para móveis

Lema

contatto
PUXADORES

Hettich



Bigfer Paraná | Curitiba - PR



Lema Embalagens | Farroupilha - RS



Filial | Votuporanga - SP

Visando alcançar diferentes segmentos de mercado e aumentar a diversidade de comercialização, agregamos alguns itens de revenda à nossa cartela de produtos. Neste catálogo você encontrará produtos para fixação, ferramentas, abrasivos, MDFs e muito mais!

Siga-nos nas redes sociais!

www.grupobigfer.com.br

 @grupo.bigfer.1

 @grupobigfer

 Grupobigfer

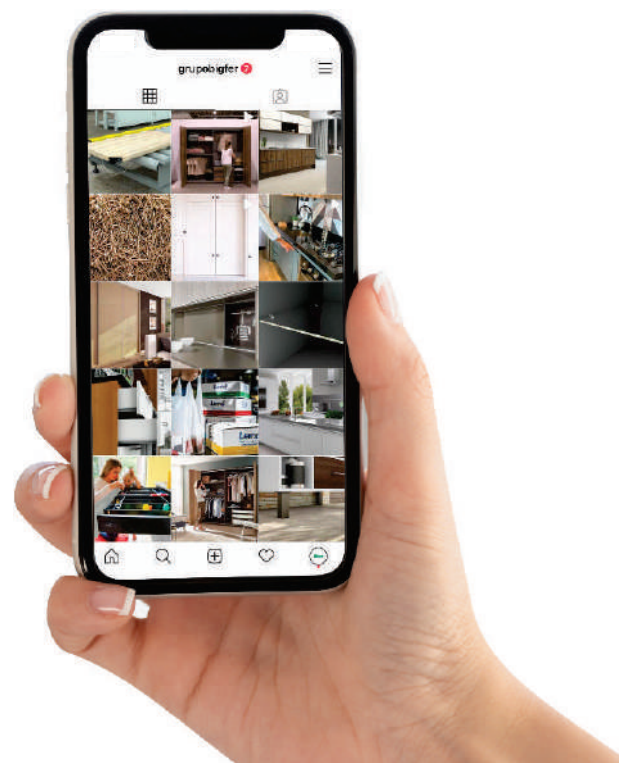

FIXAÇÃO

Parafusos - Porcas - Buchas - Grampos - Pregos - Chumbadores

05 - 13

MDF E COMPLEMENTOS

MDF - HDF - Aglomerados - Fitas de Borda - Tapa Furos

14 - 25

ABRASIVOS

Discos de Corte - Serras Circulares - Lixas

26 - 33

EPIs

Luvas - Protetores auditivos - Creme Protetor
Máscaras - Sapatos - Óculos

34 - 37

ADESIVOS

Colas - Adesivos - Silicones - Fitas Adesivas - Batentes de Silicone

38 - 41

AGROPECUÁRIOS

Esticadores - Grampos - Arames

42 - 45

DOBRADIÇAS

Pino - Dobrada - Pivotal - Borboleta

46 - 49

FECHADURAS

Externas - Internas - Banheiro - Auxiliares - Gavetas
Fechos - Cremonas - Ferrolhos - Trincos

50 - 59

FERRAMENTAS

Estiletes - Trenas - Limas - Serras - Ponteiras - Brocas

60 - 63

FERRAGENS EM GERAL

Iluminação - Correntes - Arames - Eletrodos - Abraçadeiras - Ganchos
Pitões - Rodízios - Roldanas - Guias - Suportes - Puxadores

64 - 72

The image features a background of a large pile of screws in the upper left and a close-up of a screw being driven into a surface in the lower left. The entire image is overlaid with a semi-transparent green filter. A dark teal rectangular box with a thin green border is centered in the middle, containing the word 'FIXAÇÃO' in white, bold, uppercase letters. A thin green horizontal line is positioned directly below the text.

FIXAÇÃO

PARAFUSO PARA MADEIRA CABEÇA OVAL TIPO CHIPBOARD



Código	Dimensões	Emb.
7110131481	3,5x14 (ZA)	CT
7110131491	3,5x16 (ZA)	CT
7110131531	3,5x25 (ZA)	CT
7110131841	4,0x16 (ZA)	CT
7110131861	4,0x20 (ZA)	CT
7110131881	4,0x25 (ZA)	CT

Código	Dimensões	Emb.
7110131891	4,0x30 (ZA)	CT
7110131901	4,0x35 (ZA)	CT
7110131911	4,0x40 (ZA)	CT
7110131921	4,0x45 (ZA)	CT
7110132601	4,5x35 (ZA)	CT
7110132611	4,5x40 (ZA)	CT

Código	Dimensões	Emb.
7110132631	4,5x50 (ZA)	CT
7110132651	4,5x60 (ZA)	CT
7110132971	5,0x45 (ZA)	CT
7110132981	5,0x50 (ZA)	CT
7110133001	5,0x60 (ZA)	CT

PARAFUSO P/ CORREDIÇA CAB. CHATA FENDA PHILIPS



Código	Ø Cab.	Dimensões	Emb.
7116113561	6.9	610 (ZA)	CT
7116113571	6.9	6x12 (ZA)	CT
7116113581	6.9	6x14 (ZA)	CT
7116113611	6.9	6x20 (ZA)	CT
7116113551	6.9	6x8 (ZA)	CT

Código	Ø Cab.	Dimensões	Emb.
7116193551	7.3	6x8 (ZA)	CT
7116193561	7.3	6x10 (ZA)	CT
7116193571	7.3	6x12 (ZA)	CT
7116193611	7.3	6x20 (ZA)	CT

PARAFUSO PARA MÓVEIS ESCAREADO FENDA PHILIPS



Código	Dimensões	Emb.
7017114011	7,0x40 (ZA)	CT
7017114031	7,0x50 (ZA)	CT
7017114051	7,0x60 (ZA)	CT
7017114071	7,0x70 (ZA)	CT
7017114091	7,0x80 (ZA)	CT
7017114131	7,0x100 (ZA)	CT
7017114151	7,0x120 (ZA)	CT

Cabeça 10mm Rosca Soberba

PARAFUSO PARA MÓVEIS FENDA PHILIPS



Código	Dimensões	Emb.
7017154011	7,0x40 (ZA)	CT
7017154031	7,0x50 (ZA)	CT
7017154051	7,0x60 (ZA)	CT
7017154071	7,0x70 (ZA)	CT
7017154091	7,0x80 (ZA)	CT
7017154131	7,0x100 (ZA)	CT
7017154151	7,0x120 (ZA)	CT

Cabeça 13mm Rosca Soberba

PARAFUSO PARA MÓVEIS ROSCA SOBERBA SEXTAVADO INTERNO 4MM CABEÇA 13MM



Código	Dimensões	Emb.
7017703941	7,0x16 (ZA)	CT
7017703961	7,0x20 (ZA)	CT
7017703981	7,0x25 (ZA)	CT
7017703991	7,0x30 (ZA)	CT
7017704001	7,0x35 (ZA)	CT
7017704011	7,0x40 (ZA)	CT

Código	Dimensões	Emb.
7017704021	7,0x45 (ZA)	CT
7017704031	7,0x50 (ZA)	CT
7017704051	7,0x60 (ZA)	CT
7017704071	7,0x70 (ZA)	CT
7017704091	7,0x80 (ZA)	CT
7017704111	7,0x90 (ZA)	CT

Código	Dimensões	Emb.
7017704131	7,0x100 (ZA)	CT
7017704141	7,0x110 (ZA)	CT
7017704151	7,0x120 (ZA)	CT
7017704161	7,0x130 (ZA)	CT
7017704171	7,0x140 (ZA)	CT

PARAFUSO PARA MÓVEIS ROSCA SOBERBA SEXTAVADO INTERNO 4MM CABEÇA 17MM



Código	Dimensões	Emb.
7017713991	7,0x30 (ZA)	CT
7017714011	7,0x40 (ZA)	CT
7017714031	7,0x50 (ZA)	CT
7017714051	7,0x60 (ZA)	CT
7017714071	7,0x70 (ZA)	CT
7017714091	7,0x80 (ZA)	CT

Código	Dimensões	Emb.
7017714111	7,0x90 (ZA)	CT
7017714131	7,0x100 (ZA)	CT
7017714141	7,0x110 (ZA)	CT
7017714151	7,0x120 (ZA)	CT
7017714161	7,0x130 (ZA)	CT

PARAFUSO PARA MÓVEIS ROSCA UNC SEXTAVADO INTERNO CABEÇA 13 MM



Código	Dimensões	Emb.
7070703631	1/4x25 (ZA)	CT
7070703641	1/4x30 (ZA)	CT
7070703651	1/4x35 (ZA)	CT
7070703661	1/4x40 (ZA)	CT
7070703671	1/4x45 (ZA)	CT
7070703681	1/4x50 (ZA)	CT

Código	Dimensões	Emb.
7070703701	1/4x60 (ZA)	CT
7070703711	1/4x65 (ZA)	CT
7070703721	1/4x70 (ZA)	CT
7070703731	1/4x75 (ZA)	CT
7070703741	1/4x80 (ZA)	CT
7070703761	1/4x90 (ZA)	CT

Código	Dimensões	Emb.
7070703781	1/4x100 (ZA)	CT
7070703791	1/4x110 (ZA)	CT
7070703801	1/4x120 (ZA)	CT
7070703811	1/4x130 (ZA)	CT
7070703821	1/4x140 (ZA)	CT

PARAFUSO PARA MÓVEIS ROSCA UNC SEXTAVADO INTERNO CABEÇA 17 MM



Código	Dimensões	Emb.
7070713611	1/4x20 (ZA)	CT
7070713641	1/4x30 (ZA)	CT
7070713661	1/4x40 (ZA)	CT
7070713681	1/4x50 (ZA)	CT
7070713701	1/4x60 (ZA)	CT
7070713721	1/4x70 (ZA)	CT
7070713731	1/4x75 (ZA)	CT
7070713741	1/4x80 (ZA)	CT

Código	Dimensões	Emb.
7070713761	1/4x90 (ZA)	CT
7070713781	1/4x100 (ZA)	CT
7070713791	1/4x110 (ZA)	CT
7070713801	1/4x120 (ZA)	CT
7070713811	1/4x130 (ZA)	CT
7070713821	1/4x140 (ZA)	CT
7070713831	1/4x150 (ZA)	CT

PARAFUSO PARA MÓVEIS CABEÇA LENTILHA FENDA COMBINADA



Código	Dimensões	Emb.
7070363571	1/4x1/2 (ZA)	CT
7070363591	1/4x5/8 (ZA)	CT
7070363611	1/4x3/4 (ZA)	CT
7070363621	1/4x7/8 (ZA)	CT
7070363631	1/4x1 (ZA)	CT
7070363641	1/4x1.1/4 (ZA)	CT
7070363661	1/4x1.1/2 (ZA)	CT
7070363671	1/4x1.3/4 (ZA)	CT

Código	Dimensões	Emb.
7070363681	1/4x2 (ZA)	CT
7070363711	1/4x2.1/2 (ZA)	CT
7070363721	1/4x2.3/4 (ZA)	CT
7070363731	1/4x3 (ZA)	CT
7070363741	1/4x3.1/4 (ZA)	CT
7070363761	1/4x3.1/2 (ZA)	CT
7070363781	1/4x4 (ZA)	CT
7070363811	1/4x5 (ZA)	CT

PARAFUSO SEGMENTADO C. FLANGEADA FENDA COMB.



Código	Dimensões	Emb.
7063311922	M4x45mm	CT
7063311932	M4x50mm	CT
7063311952	M4x60mm	CT

*Usado para fixação de puxadores

PARAFUSO P/ MÓVEIS ESCAREADO SEXTAVADO INTERNO



Código	Dimensões	Emb.
7017723991	7,0x30 (ZA)	CT
7017724011	7,0x40 (ZA)	CT
7017724021	7,0x45 (ZA)	CT
7017724031	7,0x50 (ZA)	CT
7017724051	7,0x30 (ZA)	CT
7017724071	7,0x70 (ZA)	CT
7017724091	7,0x80 (ZA)	CT
7017724111	7,0x90 (ZA)	CT

Cabeça 10mm Rosca Soberba

PARAFUSO MÁQUINA MÉTRICO C. FLANG. FENDA COMB.



Código	Dimensões	Emb.
7060311802	M4x8mm (ZB)	CT
7060311812	M4x10mm (ZB)	CT
7060311822	M4x12mm (ZB)	CT
7060311842	M4x16mm (ZA)	CT
7060311862	M4x20mm (ZB)	CT
7060311872	M4x22mm (ZA)	CT
7060311882	M4x25mm (ZA)	CT

*Pode ser usado para fixação de puxadores

PARAFUSO CABEÇA CILÍNDRICA COM SEXT. INTERNO 12.9



Código	Dimensões	Emb.
7970743593	1/4x5/8" (OX)	CT
7970743633	1/4x1" (OX)	CT
7970743663	1/4x1.1/2" (OX)	CT
7970743673	1/4x1.3/4" (OX)	CT
7970743683	1/4x2" (OX)	CT
7970743733	1/4x3" (OX)	CT

PARAFUSO SEXTAVADO MA933



Código	Dimensões	Emb.	Código	Dimensões	Emb.	Código	Dimensões	Emb.
7060283572	6x12 (ZB)	CT	7060283672	6x45 (ZB)	CT	7060284682	10x25 (ZB)	CT
7060283592	6x16 (ZB)	CT	7060283682	6x50 (ZB)	CT	7060284692	10x30 (ZB)	CT
7060283612	6x20 (ZB)	CT	7060283702	6x60 (ZB)	CT	7060284712	10x40 (ZB)	CT
7060283622	6x22 (ZB)	CT	7060284312	8x20 (ZB)	CT	7060284722	10x45 (ZB)	CT
7060283632	6x25 (ZB)	CT	7060284332	8x25 (ZB)	CT	7060284731	10x50 (ZB)	CT
7060283642	6x30 (ZB)	CT	7060284342	8x30 (ZB)	CT	7060284752	10x60 (ZB)	CT
7060283652	6x35 (ZB)	CT	7060284362	8x40 (ZB)	CT			
7060283662	6x40 (ZB)	CT	7060284382	8x50 (ZB)	CT			

PARAFUSO SEXTAVADO UNC ROSCA INTEIRA



Código	Dimensões	Emb.	Código	Dimensões	Emb.	Código	Dimensões	Emb.
7070282932	3/16x1 (ZB)	CT	7070283692	1/4x2.1/4 (ZB)	CT	7070284312	5/16x3/4 (ZB)	CT
7070282962	3/16x1.1/2 (ZB)	CT	7070283722	1/4x2.3/4 (ZB)	CT	7070284482	5/16x4 (ZB)	CT
7070282942	3/16x1.1/4 (ZB)	CT	7070283732	1/4x3 (ZB)	CT	7070284672	3/8x7/8 (ZB)	CT
7070282972	3/16x1.3/4 (ZB)	CT	7070283762	1/4x3.1/2 (ZB)	CT	7070284682	3/8x1 (ZB)	CT
7070282872	3/16x1/2 (ZB)	CT	7070283782	1/4x4 (ZB)	CT	7070284712	3/8x1.1/2 (ZB)	CT
7070282912	3/16x3/4 (ZB)	CT	7070284292	5/16x5/8 (ZB)	CT	7070284692	3/8x1.1/4 (ZB)	CT
7070282892	3/16x5/8 (ZB)	CT	7070284332	5/16x1 (ZB)	CT	7070284722	3/8x1.3/4 (ZB)	CT
7070283592	1/4x5/8 (ZB)	CT	7070284322	5/16x7/8 (ZB)	CT	7070284732	3/8x2 (ZB)	CT
7070283612	1/4x3/4 (ZB)	CT	7070284362	5/16x1.1/2 (ZB)	CT	7070284782	3/8x3 (ZB)	CT
8170283622	1/4x7/8 (ZB)	CT	7070284342	5/16x1.1/4 (ZB)	CT	7070284812	3/8x3.1/2 (ZB)	CT
7070283632	1/4x1 (ZB)	CT	7070284372	5/16x1.3/4 (ZB)	CT	7070284832	3/8x4 (ZB)	CT
7070283633	1/4x1 (ZP)	CT	7070284272	5/16x1/2 (ZB)	CT	7070285382	1/2x1 (ZB)	CT
7070283662	1/4x1.1/2 (ZB)	CT	7070284382	5/16x2 (ZB)	CT	7070285412	1/2x1.1/2 (ZB)	CT
7070283642	1/4x1.1/4 (ZB)	CT	7070284412	5/16x2.1/2 (ZB)	CT	7070285392	1/2x1.1/4 (ZB)	CT
7070283672	1/4x1.3/4 (ZB)	CT	7070284392	5/16x2.1/4 (ZB)	CT	7070285422	1/2x1.3/4 (ZB)	CT
7070283572	1/4x1/2 (ZB)	CT	7070284422	5/16x2.3/4 (ZB)	CT	7070285432	1/2x2 (ZB)	CT
7070283682	1/4x2 (ZB)	CT	7070284432	5/16x3 (ZB)	CT	7070285462	1/2x2.1/2 (ZB)	CT
7070283712	1/4x2.1/2 (ZB)	CT	7070284462	5/16x3.1/2 (ZB)	CT	7070285482	1/2x3 (ZB)	CT

PARAFUSO SEXTAVADO UNC ROSCA PARCIAL



Código	Dimensões	Emb.	Código	Dimensões	Emb.	Código	Dimensões	Emb.
7073283670	1/4x1.3/4" (PO)	CT	7073284390	5/16x2.1/4" (PO)	CT	7073284740	3/8x2.1/4" (PO)	CT
7073283680	1/4x2" (PO)	CT	7073284410	5/16x2.1/2" (PO)	CT	7073284760	3/8x2.1/2" (PO)	CT
7073283690	1/4x2.1/4" (PO)	CT	7073284420	5/16x2.3/4" (PO)	CT	7073284770	3/8x2.3/4" (PO)	CT
7073283710	1/4x2.1/2" (PO)	CT	7073284430	5/16x3" (PO)	CT	7073284780	3/8x3" (PO)	CT
7073283720	1/4x2.3/4" (PO)	CT	7073284460	5/16x3.1/2" (PO)	CT	7073284810	3/8x3.1/2" (PO)	CT
7073283730	1/4x3" (PO)	CT	7073284480	5/16x4" (PO)	CT	7073284830	3/8x4" (PO)	CT
7073283760	1/4x3.1/2" (PO)	CT	7073284490	5/16x4.1/2" (PO)	CT	7073284840	3/8x4.1/2" (PO)	CT
7073283780	1/4x4" (PO)	CT	7073284510	5/16x5" (PO)	CT	7073284860	3/8x5" (PO)	CT
7073283790	1/4x4.1/2" (PO)	CT	7073284520	5/16x5.1/2" (PO)	CT	7073284870	3/8x5.1/2" (PO)	CT
7073283810	1/4x5" (PO)	CT	7073284530	5/16x6" (PO)	CT	7073284880	3/8x6" (PO)	CT
7073284370	5/16x1.3/4" (PO)	CT	7073284720	3/8x1.3/4" (PO)	CT			
7073284380	5/16x2" (PO)	CT	7073284730	3/8x2" (PO)	CT			

PARAFUSO SEXTAVADO ROSCA SOBERBA



Código	Dimensões	Emb.	Código	Dimensões	Emb.	Código	Dimensões	Emb.
7019283642	1/4x30 (ZB)	CT	7019283722	1/4x70 (ZB)	CT	7019284392	5/16x55 (ZB)	CT
7019283652	1/4x35 (ZB)	CT	7019283732	1/4x75 (ZB)	CT	7019284402	5/16x60 (ZB)	CT
7019283662	1/4x40 (ZB)	CT	7019283742	1/4x80 (ZB)	CT	7019284412	5/16x65 (ZB)	CT
7019283672	1/4x45 (ZB)	CT	7019283762	1/4x90 (ZB)	CT	7019284422	5/16x70 (ZB)	CT
7019283682	1/4x50 (ZB)	CT	7019283782	1/4x100 (ZB)	CT	7019284432	5/16x75 (ZB)	CT
7019283683	1/4x50 (ZP)	CT	7019284342	5/16x30 (ZB)	CT	7019284442	5/16x80 (ZB)	CT
7019283692	1/4x55 (ZB)	CT	7019284362	5/16x40 (ZB)	CT	7019284462	5/16x90 (ZB)	CT
7019283702	1/4x60 (ZB)	CT	7019284372	5/16x45 (ZB)	CT	7019284482	5/16x100 (ZB)	CT
7019283712	1/4x65 (ZB)	CT	7019284382	5/16x50 (ZB)	CT			

PARAFUSO FRANCÊS COM PORCA SEXTAVADA



Código	Dimensões	Emb.	Código	Dimensões	Emb.	Código	Dimensões	Emb.
7070292912	3/16x3/4 (ZB)	CT	7070294372	5/16x1.3/4 (ZB)	CT	7070294842	3/8x4.1/2 (ZB)	CT
7070292932	3/16x1 (ZB)	CT	7070294382	5/16x2 (ZB)	CT	7070294862	3/8x5 (ZB)	CT
7070292962	3/16x1.1/2 (ZB)	CT	7070294412	5/16x2.1/2 (ZB)	CT	7070294872	3/8x5.1/2 (ZB)	CT
7070292942	3/16x1.1/4 (ZB)	CT	7070294392	5/16x2.1/4 (ZB)	CT	7070294882	3/8x6 (ZB)	CT
7070292972	3/16x1.3/4 (ZB)	CT	7070294422	5/16x2.3/4 (ZB)	CT	7070294902	3/8x6.1/2 (ZB)	CT
7070292982	3/16x2 (ZB)	CT	7070294432	5/16x3 (ZB)	CT	7070298782	3/8x7 (ZB)	CT
7070293612	1/4x3/4 (ZB)	CT	7070294462	5/16x3.1/2 (ZB)	CT	7070298922	3/8x7.1/2 (ZB)	CT
7070293632	1/4x1 (ZB)	CT	7070294442	5/16x3.1/4 (ZB)	CT	7070299062	3/8x8 (ZB)	CT
7070293662	1/4x1.1/2 (ZB)	CT	7070294482	5/16x4 (ZB)	CT	7070298432	3/8x8.1/2 (ZB)	CT
7070293642	1/4x1.1/4 (ZB)	CT	7070294492	5/16x4.1/2 (ZB)	CT	7070299202	3/8x9 (ZB)	CT
7070293672	1/4x1.3/4 (ZB)	CT	7070294512	5/16x5 (ZB)	CT	7070298572	3/8x9.1/2 (ZB)	CT
7070293572	1/4x1/2 (ZB)	CT	7070294522	5/16x5.1/2 (ZB)	CT	7070299342	3/8x10 (ZB)	CT
7070293682	1/4x2 (ZB)	CT	7070294532	5/16x6 (ZB)	CT	7070295412	1/2x1.1/2 (ZB)	CT
7070293712	1/4x2.1/2 (ZB)	CT	7070294552	5/16x6.1/2 (ZB)	CT	7070295462	1/2x2.1/2 (ZB)	CT
7070293692	1/4x2.1/4 (ZB)	CT	7070298772	5/16x7 (ZB)	CT	7070295482	1/2x3 (ZB)	CT
7070293722	1/4x2.3/4 (ZB)	CT	7070298912	5/16x7.1/2 (ZB)	CT	7070295512	1/2x3.1/2 (ZB)	CT
7070293732	1/4x3 (ZB)	CT	7070299052	5/16x8 (ZB)	CT	7070295532	1/2x4 (ZB)	CT
7070293762	1/4x3.1/2 (ZB)	CT	7070298422	5/16x8.1/2 (ZB)	CT	7070295542	2x4.1/2 (ZB)	CT
7070293742	1/4x3.1/4 (ZB)	CT	7070299192	5/16x9 (ZB)	CT	7070295562	1/2x5 (ZB)	CT
7070293782	1/4x4 (ZB)	CT	7070294682	3/8x1 (ZB)	CT	7070295572	1/2x5.1/2 (ZB)	CT
7070293792	1/4x4.1/2 (ZB)	CT	7070294712	8x1.1/2 (ZB)	CT	7070295582	1/2x6 (ZB)	CT
7070293812	1/4x5 (ZB)	CT	7070294732	3/8x2 (ZB)	CT	7070295602	2x6.1/2 (ZB)	CT
7070293822	1/4x5.1/2 (ZB)	CT	7070294762	3/8x2.1/2 (ZB)	CT	7070298802	1/2x7 (ZB)	CT
7070293832	1/4x6 (ZB)	CT	7070294742	3/8x2.1/4 (ZB)	CT	7070298942	2x7.1/2 (ZB)	CT
7070294272	5/16x1/2 (ZB)	CT	7070294772	3/8x2.3/4 (ZB)	CT	7070299082	1/2x8 (ZB)	CT
7070294312	5/16x3/4 (ZB)	CT	7070294782	3/8x3 (ZB)	CT	7070299222	1/2x9 (ZB)	CT
7070294332	5/16x1 (ZB)	CT	7070294812	3/8x3.1/2 (ZB)	CT	7070299362	1/2x10 (ZB)	CT
7070294362	5/16x1.1/2 (ZB)	CT	7070294792	3/8x3.1/4 (ZB)	CT			
7070294342	5/16x1.1/4 (ZB)	CT	7070294832	3/8x4 (ZB)	CT			

PARAFUSO PARA PLÁSTICO CABEÇA PANELA FENDA PHILIPS



Código	Dimensões	Emb.	Código	Dimensões	Emb.
7140181452	3,5x8mm (ZB)	CT	7140181532	3,5x25mm (ZB)	CT
7140181472	3,5x12mm (ZB)	CT	7140181542	3,5x30mm (ZB)	CT
7140181492	3,5x16mm (ZB)	CT	7140181562	3,5x40mm (ZB)	CT
7140181512	3,5x20mm (ZB)	CT	7140181882	4,0x25mm (ZB)	CT
7140181522	3,5x22mm (ZB)	CT			

PARAFUSO AUTO ATARRAXANTE CABEÇA PANELA FENDA PHILIPS



Código	Dimensões	Emb.	Código	Dimensões	Emb.	Código	Dimensões	Emb.
7120120072	2.2x13 (ZB)	CT	7120121872	3.9x22 (ZB)	CT	7120122982	4.8x50 (ZB)	CT
7120120042	2.2x6.5 (ZB)	CT	7120121882	3.9x25 (ZB)	CT	7120123222	5.5x13 (ZB)	CT
7120120062	2.2x9.5 (ZB)	CT	7120121892	3.9x32 (ZB)	CT	7120123242	5.5x16 (ZB)	CT
7120120772	2.9x13 (ZB)	CT	7120122162	4.2x9.5 (ZB)	CT	7120123262	5.5x19 (ZB)	CT
7120120792	2.9x16 (ZB)	CT	7120122172	4.2x13 (ZB)	CT	7120123272	5.5x22 (ZB)	CT
7120120812	2.9x19 (ZB)	CT	7120122192	4.2x16 (ZB)	CT	7120123282	5.5x25 (ZB)	CT
7120120742	2.9x6.5 (ZB)	CT	7120122212	4.2x19 (ZB)	CT	7120123292	5.5x32 (ZB)	CT
7120120762	2.9x9.5 (ZB)	CT	7120122222	4.2x22 (ZB)	CT	7120123312	5.5x38 (ZB)	CT
7120121472	3.5x13 (ZB)	CT	7120122232	4.2x25 (ZB)	CT	7120123322	5.5x45 (ZB)	CT
7120121492	3.5x16 (ZB)	CT	7120122242	4.2x32 (ZB)	CT	7120123332	5.5x50 (ZB)	CT
7120121512	3.5x19 (ZB)	CT	7120122262	4.2x38 (ZB)	CT	7120123572	6.3x13 (ZB)	CT
7120121522	3.5x22 (ZB)	CT	7120122862	4.8x9.5 (ZB)	CT	7120123592	6.3x16 (ZB)	CT
7120121532	3.5x25 (ZB)	CT	7120122872	4.8x13 (ZB)	CT	7120123612	6.3x19 (ZB)	CT
7120121442	3.5x6.5 (ZB)	CT	7120122892	4.8x16 (ZB)	CT	7120123622	6.3x22 (ZB)	CT
7120121462	3.5x9.5 (ZB)	CT	7120122912	4.8x19 (ZB)	CT	7120123632	6.3x25 (ZB)	CT
7120121812	3.9x9.5 (ZB)	CT	7120122922	4.8x22 (ZB)	CT	7120123662	6.3x38 (ZB)	CT
7120121822	3.9x13 (ZB)	CT	7120122932	4.8x25 (ZB)	CT	7120123672	6.3x45 (ZB)	CT
7120121842	3.9x16 (ZB)	CT	7120122942	4.8x32 (ZB)	CT	7120123682	6.3x50 (ZB)	CT
7120121862	3.9x19 (ZB)	CT	7120122972	4.8x45 (ZB)	CT			

PARAFUSO AUTO ATARRAXANTE CABEÇA CHATA FENDA PHILIPS



Código	Dimensões	Emb.	Código	Dimensões	Emb.	Código	Dimensões	Emb.
7120110042	2.2x6.5 (ZB)	CT	7120111863	3.9x19 (ZP)	CT	7120112912	4.8x19 (ZB)	CT
7120110062	2.2x9.5 (ZB)	CT	7120111872	3.9x22 (ZB)	CT	7120112932	4.8x25 (ZB)	CT
7120110072	2.2x13 (ZB)	CT	7120111882	3.9x25 (ZB)	CT	7120112942	4.8x32 (ZB)	CT
7120110742	2.9x6.5 (ZB)	CT	7120111892	3.9x32 (ZB)	CT	7120112962	4.8x38 (ZB)	CT
7120110772	2.9x13 (ZB)	CT	7120112162	4.2x9.5 (ZB)	CT	7120112972	4.8x45 (ZB)	CT
7120110812	2.9x19 (ZB)	CT	7620110832	4.2x12 (ZB)	CT	7120112982	4.8x50 (ZB)	CT
7120111442	3.5x6.5 (ZB)	CT	7120112172	4.2x13 (ZB)	CT	7120113282	5.5x25 (ZB)	CT
7120111462	3.5x9.5 (ZB)	CT	7120112182	4.2x14 (ZB)	CT	7120113292	5.5x32 (ZB)	CT
7120111472	3.5x13 (ZB)	CT	7120112192	4.2x16 (ZB)	CT	7120113312	5.5x38 (ZB)	CT
7120111482	3.5x14 (ZB)	CT	7120112212	4.2x19 (ZB)	CT	7120113322	5.5x45 (ZB)	CT
7120111492	3.5x16 (ZB)	CT	7120112222	4.2x22 (ZB)	CT	7120113332	5.5x50 (ZB)	CT
7120111512	3.5x19 (ZB)	CT	7120112232	4.2x25 (ZB)	CT	7120113572	6.3x13 (ZB)	CT
7120111522	3.5x22 (ZB)	CT	7120112242	4.2x32 (ZB)	CT	7120113612	6.3x19 (ZB)	CT
7120111532	3.5x25 (ZB)	CT	7120112262	4.2x38 (ZB)	CT	7120113622	6.3x22 (ZB)	CT
7120111812	3.9x9.5 (ZB)	CT	7120112272	4.2x45 (ZB)	CT	7120113662	6.3x38 (ZB)	CT
7120111822	3.9x13 (ZB)	CT	7120112282	4.2x50 (ZB)	CT	7120113672	6.3x45 (ZB)	CT
7120111842	3.9x16 (ZB)	CT	7120112862	4.8x9.5 (ZB)	CT	7120113682	6.3x50 (ZB)	CT
7120111862	3.9x19 (ZB)	CT	7120112892	4.8x16 (ZB)	CT			

PORCA SEXTAVADA UNC



Código	Descrição	Emb.	Código	Descrição	Emb.
0903156901	3/16 chv 5/16 (s/ acabamento)	CT	0903152411	1/4 chv 3/8 (ZB)	CT
0903153901	1/4 chv 7/16 (s/ acabamento)	CT	0903159411	5/16 chv 1/2 (ZB)	CT
0903159901	5/16 chv 1/2 (s/ acabamento)	CT	0903158411	3/8 chv 9/16 (ZB)	CT
0903158901	3/8 chv 9/16 (s/ acabamento)	CT	0903162411	7/16 chv 5/8 (ZB)	CT
0903154411	1/8 chv 1/4 (ZB)	CT	0903151411	1/2 chv 3/4 (ZB)	CT
0903160411	5/32 chv 5/16 (ZB)	CT	0903161411	5/8 chv 15/16 (ZB)	CT
0903156411	3/16 chv 5/16 (ZB)	CT	0903157411	3/4 chv 1.1/8 (ZB)	CT
0903155411	3/16 chv 3/8 (ZB)	CT	0903147411	1 chv 1.1/2 (ZB)	CT
0903153411	1/4 chv 7/16 (ZB)	CT			

PARAFUSO TELHA HASTE 1/4"



Código	Dimensões	Emb.
7619270232	5/16x10 sem arruela e sem chupeta (ZB)	CT
7619270462	1/4 - 5/16x130 sem arruela e sem chupeta (ZB)	CT

Códigos: Chupeta - 06.02.008.138 | Arruela - 09.05.002.411

CONJUNTO PARAFUSO TELHEIRO COMPLETO



Código	Dimensões	Emb.
0901072411	Haste Ø1/4"- 5/16"x110mm (ZB)	CT
0901106411	Haste Ø1/4"- 5/16"x150mm (ZB)	CT

PORCA AUTO TRAVANTE



Código	Descrição	Emb.
0903115411	M6 chv 10 baixa (6,0mm) ZB	CT
0903112411	1/4 chv 7/16 alta (8,5mm) ZB	CT
0903114411	5/16 chv 1/2 alta (9,0mm) ZB	CT

PORCA SEXTAVADA MA



Código	Descrição	Emb.
0903135411	MA 4 chv 7 (ZB)	CT
0903137411	MA 5 chv 8 (ZB)	CT
0903139411	MA 6 chv 10 (ZB)	CT
0903140411	MA 8 (ZB)	CT
0903141411	MA 10 (ZB)	CT

PORCA BORBOLETA UNC



Código	Descrição	Emb.
903118411	3/16 (r) (ZB)	CT
903117411	1/4 (r) (ZB)	CT

BUCHA PARA GESSO NYLON



Código	Descrição	Emb.
2001003471	FLY2 10x35	CT
2001002871	FLY3 10x40	CT

BUCHA PARA GESSO K54



Código	Emb.
9146000110	CT

BUCHA MU 8 PLÁSTICA



Código	Emb.
2001001862	UN

BUCHA NYLON S



Código	Descrição	Emb.
9146000011	5 Cinza	CT
9146000035	7 Cinza	CT
9146000059	10 Cinza	CT
33272	6 Marfim	UN
33273	8 Marfim	UN
*9146000067	8 com aba Cinza	CT

*S8 com aba

BUCHA NYLON FU



Código	Descrição	Emb.
9146000073	06x35	CT
9146000080	08x50	CT
9146000097	10x60	CT

BUCHA NYLON UX



Código	Descrição	Emb.
9146000042	6x35 c/ aba	CT
9146000007	8x50 c/ aba	CT

BUCHA NYLON SX



Código	Descrição	Emb.
9146000012	6x30	CT
9146000013	8x40	CT

BUCHA PLÁSTICA



Código	Descrição	Emb.
9112003008	05	CT
9112003022	07	CT
9112003046	10	CT
4460041404	6 PP Cinza	UN
4460051400	8 PP Cinza	UN

BUCHA HDF



Código	Emb.
9146000002	CT

BUCHA SFORBOLT 1/4 (TOGGLE)



Código	Descrição	Emb.
2001001866	Com PF 1/4x2.1/2	CT

BUCHA DUOTEC



Código	Emb.
9146000020	CT

HASTE ROSCADA POLIDA (MEIO MAQ. MEIO SOBERBA)



Código	Dimensões	Emb.
9147023705	1/4x70mm	CT
9147025013	5/16x45mm	CT
9147023600	5/16x55mm	CT
9147024702	5/16x90mm	CT

FIXA FIO COAXIAL



Código	Descrição	Emb.
2001002912	6mm	CT

GRAMPO LINHA



Código	Descrição	Emb.
9114000272	Linha 14/25	MIL
9114000296	Linha 14/30	MIL
9114000302	Linha 14/38	MIL
9114000319	Linha 14/45	MIL
9114000326	Linha 14/50	MIL
9114000159	Linha 80/06	MIL

Código	Descrição	Emb.
9114000173	Linha 80/08	MIL
2001000522	Linha 80/10	MIL
9114000180	Linha 80/12	MIL
9114000197	Linha 80/14	MIL
9114000234	Linha 92/25	MIL

GRAMPO LINHA F PINO

Código	Descrição	Emb.
9114000333	Linha F10	MIL
9114000340	Linha F15	MIL
9114000357	Linha F20	MIL
9114000364	Linha F25	MIL
9114000388	Linha F30	MIL

Código	Descrição	Emb.
9114000401	Linha F35	MIL
9114000425	Linha F40	MIL
9114000432	Linha F45	MIL
9114000449	Linha F50	MIL

GRAMPO LINHA PCN

Código	Descrição	Emb.
9114000081	50/16	MIL

ROLO DE FITA PERFURADA EXTRA LEVE

Código	Descrição	Emb.
9149000339	0,5x17x30m	UN

PREGO CABEÇA DUPLA

Código	Descrição	Emb.
1738033025	17x27-2.1/2x11	KG
1738039126	18x30-2.3/4x10	KG

PREGO TELHEIRO

Código	Descrição	Emb.
1738693878	18x27-2.1/2x10	KG
1738347542	18x30-2.3/4x10	KG
1738693885	18x36-3.1/4x10	KG

PREGO ARDOX

Código	Descrição	Emb.
1738235146	12x12-1.1/6x15,5	KG
1738235153	13x15-1.1/4x15	KG
1738474866	15x21-2x13	KG
1738235207	16x24-2.1/4x12	KG
1738235221	17x24-2.1/4x11	KG
1738234392	17x27-2.1/2x11	KG

PREGO ANELADO

Código	Descrição	Emb.
1738235290	12x12-1.1/6x15,5	KG
1738235306	13x15-1.1/4x15	KG
2001002794	12x10 (1.8x22)	KG

PREGO SEM CABEÇA

Código	Descrição	Emb.
1738445804	7X9-3/4X19	KG
1738445750	10X10-7/8X17	KG
1738039058	11X15-1.1/4X16	KG
1738039065	12X12-1.1/6X15,5	KG

Código	Descrição	Emb.
1738019371	13X15-1.1/4X15	KG
1738019395	14X21-2X14	KG
1738039096	16X24-2.1/4X12	KG
1738346484	17X27-2.1/2X11	KG

PREGO COM CABEÇA



Código	Descrição	Emb.
1738445705	8x8-1.1/16x18	KG
1738445866	10x7-5/8x17	KG
1738445620	10x10-7/8x17	KG
1738028915	12x12-1.1/6x15.5	KG
1738028922	12x15-1.1/6x15.5	KG
1738018787	13x15-1.1/4x15	KG
1738018831	14x21-2x14	KG
1738018862	15x18-1.1/2x13	KG
1738018879	15x21-2x13	KG
1738018909	16x21-2x12	KG
1738028946	16x24-2.1/4x12	KG
1738018954	17x27-2.1/2x11	KG
1738018985	18x24-2.1/4x10	KG
1738018992	18x27-2.1/2x10	KG

Código	Descrição	Emb.
1738019005	18x30-2.3/4x10	KG
1738019029	18x36-3.1/4x10	KG
1738019081	19x36-3.1/4x9	KG
1738019098	19x39-3.1/2x9	KG
1738028977	20x48-4.1/4x7	KG
1738019197	21x45-4x6	KG
1738019234	22x48-4.1/4x5	KG
1738019258	22x54-5x5	KG
1738029028	23x54-5x4	KG
1738029035	23x60-5.1/2x4	KG
1738029059	24x66-6x3	KG
1738029080	25x72-6.1/2x2	KG
1738029103	26x84-7.1/2x1	KG

CHUMBADOR PBA



Código	Descrição	Emb.
9149000001	1/4X 1.3/4	UN
7637110001	1/4 X 2.1/4	UN
9149000032	1/4X 3.1/4	UN
7637110008	5/16 X 2	UN
7637110812	5/16 X 3.1/4	UN
7637125786	5/16 X 4.1/4	UN
7637110010	3/8 X 2.1/4	UN
7637110002	3/8 X 2.3/4	UN
7637110003	3/8 X 3	UN
7637110004	3/8 X 3.1/2	UN
7637118252	3/8 X 3.3/4	UN

Código	Descrição	Emb.
7637125779	3/8 X 5	UN
7637119600	1/2 X 2.3/4	UN
7637110009	1/2 X 3.3/4	UN
7637110005	1/2 X 4	UN
9149000179	1/2 X 4.1/4	UN
7637110007	1/2 X 5.1/2	UN
7637110006	1/2 X 7	UN
9149000209	5/8 X 3.1/2	UN
9149000248	5/8 X 6	UN
9149000247	5/8 X 7	UN
9149000261	3/4 X 4.1/4	UN

The background features a stack of light-colored wood panels on the left, a dark green textured surface on the right, and a stack of panels with circular patterns at the bottom left. A dark teal rectangular box with a thin green border is centered in the middle of the image.

MDF E COMPLEMENTOS

AGLOMERADOS



Código	Descrição	Código	Descrição
9141200172	Amantea Tatto 18x2,75x1,85 2L	9144100438	Frassino Almendra 15x2,75x1,85
9143100196	Barrique Tatto 15x2,75x1,85 2L	9144100320	Frassino Whiskey 18x2,75x1,85 2L
9141200676	Barrique Tatto 18x2,75x1,85 2L	9141200423	Gengibre Tatto 15x2,75x1,85 2L
9143100008	Barrique Tatto 25x2,75x1,85 2L	9144100298	Gengibre Tatto 18x2,75x1,85 2L
9144100021	Baumkuchen Tatto 15x2,75x1,85 2L	9141200128	Italian Noce 25x2,75x1,85 2L
9144100162	Bege Tx 15x2,75x1,85 2L	9143100203	Linen Grigio Vel 15x2,75x1,85 2L
9144100318	Bege Tx 18x2,75x1,85 2L	9141200752	Louro Freijó Grann 15x2,75x1,85 2L
9144100321	Bege Tx 25x2,75x1,85 2L	9141200584	Maple Poro 15x2,75x1,85 2L
9143100202	Branco Liso 12x2,75x1,85 2L	9144100165	Maple Poro 18x2,75x1,85 2L
9144100284	Branco Liso 15x2,75x1,85 2L	9144100395	Metallic Suede TX 15x2,75x1,85 2L
9140300030	Branco Liso 18x2,75x1,85 2L	9144100441	Metallic Suede TX 18x2,75x1,85 2L
9144100188	Branco Liso 25x2,75x1,85 2L	9144100440	Metallic Suede TX 25x2,75x1,85 2L
9144100161	Branco Tx 15x2,75x1,85 2L	9141201317	Nogal Malaga 15x2,75x1,85 2L
9144100074	Branco Tx 18x2,75x1,85 2L	9144100388	Nogal Malaga 25x2,75x1,85 2L
9144100073	Branco Tx 25x2,75x1,85 2L	9144100309	Nogal Sevilha 15x2,75x1,85 2L
9144100437	Calcare Vel 15x2,75 X1,85 2L	9144100310	Nogal Sevilha 25x2,75x1,85 2L
9144100433	Calcare Vel 25x2,75x1,85 2L	9141200447	Nude Vel 15x2,75x1,85 2L
9141200657	Carvalho Nice 18x2,75x1,85 2L	9141200449	Nude Vel 18x2,75x1,85 2L
9144100325	Carvalho Treviso Poro 15x2,75x1,85 2L	9141201302	Palissandro Ártico 15x2,75x1,85 2L
9144100294	Carvalho Treviso Poro 25x2,75x1,85 2L	9142000022	Peroba Tatto 15x2,75x1,85 2L
9144100256	Chiaro Vel 15x2,75x1,85 2L	9144100039	Preto Tx 15x2,75x1,85 2L
9144100435	Chumbo 15x2,75x1,85 2L	9141200119	Preto Tx 18x2,75x1,85 2L
9144100434	Cinamomo Grann 15x2,75x1,85 2L	9141200120	Preto Tx 25x2,75x1,85 2L
9141200963	Cinza Argila Tx 15x2,75x1,85 2L	9141200157	Wengue Valência 15x2,75x1,85 2L
9141200961	Cinza Argila Tx 18x2,75x1,85 2L	9141200448	Wengue Valência 25x2,75x1,85 2L
9144100301	Cinza Argila Tx 25x2,75x1,85 2L	9144100029	Cru 12x2,75x1,85
9141200960	Cinza Cobalto Vel 15x2,75x1,85 2L	9144100093	Cru 12x2,75x2,20
9144100160	Cinza Cristal Tx 15x2,7x1,85 2L	1680120007	Cru 15x2,75x1,85
9141200669	Cinza Cristal Tx 18x2,75x1,85 2L	9144100028	Cru 15x2,75x2,20
9141200959	Cinza Cristal Tx 25x2,75x1,85 2L	9141200164	Cru 18x2,75x1,85
9144100376	Cru Plus 15x2,75x1,85	9141200171	Cru 25x2,75x1,85
9144100394	Damasco Tx 18x2,75x1,85 2L	9140301300	Plus Branco Ártico 15x2,75x1,85 2L
9144100354	Faia 18x2,75x1,85 2L	9140301343	Plus Branco Ártico 18x2,75x1,85 2L

HDF

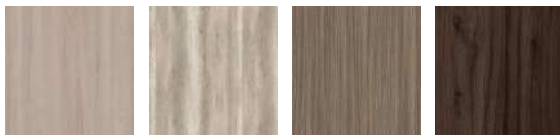

Código	Descrição	Código	Descrição
9144100176	Cru Berneck 2,5x2,75x1,85	9144100024	Cru Berneck 4,0x2,75x1,85
9144100187	Cru Berneck 2,5x2,75x2,13	9144100018	Cru Berneck 06x2,75x1,85
1680160009	Cru Berneck 2,5x2,75x2,20	9144100031	Cru Berneck 06x2,75x2,13
9144100027	Cru Berneck 2,8x2,75x1,85	9140301022	Cru Plus Berneck 03x2,75x2,13
9144100429	Cru Berneck 2,8x2,44x2,13	9142000084	Cru Plus Berneck 06x2,75x1,85
9144100432	Cru Berneck 2,8x2,75x2,13	9144100289	Cru Plus Berneck 06x2,75x2,13
9144100026	Cru Berneck 3,0x2,75x1,85	9140300256	Branco Pintado 3,0x2,75x1,84 1L Eucatex
9144100037	Cru Berneck 3,0x2,75x2,13		

HDF BP LINHA TATTO

Amantea Barrique Baumkuchen Castaine



Gengibre Peroba Provence

Código	Descrição
9144100251	Amantea 06x2,75x1,85 2L
9144100265	Barrique 06x2,75x1,85 2L
9144100268	Baumkuchen 06x2,75x1,85 2L
9144100259	Castaine 06x2,75x1,85 2L
9144100216	Gengibre 06x2,75x1,85 2L
9144100197	Peroba 06x2,75x1,85 2L
9144100281	Provence 06x2,75x1,85 2L

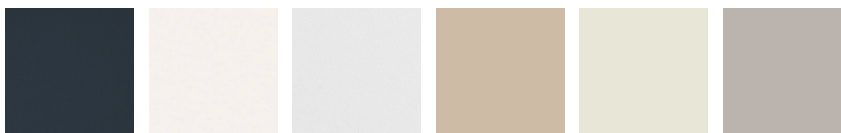
HDF BP LINHA TX

Azul Mineral Branco Liso/Plus Branco Ártico Bege Cinza Argila Cinza Cobalto



Cinza Cristal Marquina Metallic Suede Preto Ruggine Damasco

Código	Descrição
9141200836	Azul Mineral 06x2,75x1,85 2L
9144100002	Branco Ártico 06x2,75x1,85 1L
9144100003	Branco Ártico 06x2,75x1,85 2L
9144100172	Branco Liso 06x2,75x1,85 2L
9144100089	Branco Plus 06x2,75x1,84 2L
9144100066	Bege 06x2,75x1,85 1L
9144100247	Bege 06x2,75x1,85 2L
9144100141	Cinza Argila 06x2,75x1,85 2L
9144100239	Cinza Cobalto 06x2,75x1,85 2L
9141200017	Cinza Cristal 06x2,75x1,85 2L
9144100397	Marquina 06x2,75x1,85 2L
9144100236	Metallic Suede 06x2,75x1,85 2L
9144100044	Preto 06x2,75x1,85 1L
9144100364	Preto 06x2,75x1,85 2L
9144100330	Ruggine 06x2,75x1,85 2L
9144100148	Damasco 06x2,75x1,85 2L

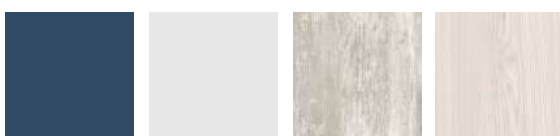
HDF BP LINHA VEL

Azul Branco Calcare Chiaro



Cinza Cobalto Linen Grigio Nude Panamá

Código	Descrição
9144100227	Azul 06x2,75x1,85 2L
9144100233	Branco 06x2,75x1,85 2L
9144100342	Calcare 06x2,75x1,85 2L
9144100210	Chiaro 06x2,75x1,85 2L
9144100222	Cinza Cobalto 06x2,75x1,85 2L
9144100232	Linen Grigio 06x2,75x1,85 2L
9144100345	Nude 06x2,75x1,85 2L
9144100421	Panamá 06x2,75x1,85 2L

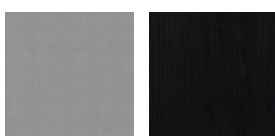
HDF BP LINHA RUST

Argento Nero

Código	Descrição
9144100351	Argento 06x2,75x1,85 2L
9144100348	Nero 06x2,75x1,85 2L

HDF BP LINHA DESIGN



Branco Carvalho Treviso Nogal Malaga Nogal Turin Preto

Código	Descrição
9144100069	Branco 06x2,75x1,85 2L
9144100145	Carvalho Treviso 06x2,75x1,85 2L
9144100108	Nogal Malaga 06x2,75x1,85 2L
9144100111	Nogal Turin 06x2,75x1,85 2L
9144100138	Preto 06x2,75x1,85 2L

HDF BP LINHA PORO



Carvalho Atenas Carvalho Nice Carvalho Treviso Frassino Almendra Frassino Whiskey



Italian Noce Maple Nogal Sevilha Palissandro Ártico Wengue Valência



Wengue Ravenna

Código	Descrição
9144100098	Carvalho Atenas 06x2,75x1,85 2L
9144100123	Carvalho Nice 06x2,75x1,85 2L
9144100063	Carvalho Treviso 06x2,75x1,85 2L
9144100051	Frassino Almendra 06x2,75x1,85 2L
9144100117	Frassino Whiskey 06x2,75x1,85 2L
9144100135	Italian Noce 06x2,75x1,85 2L
9144100047	Maple 06x2,75x1,85 2L
9144100060	Nogal Sevilha 06x2,75x1,85 2L
9144100357	Palissandro Ártico 06x2,75x1,85 2L
9144100155	Wengue Valência 06x2,75x1,85 2L
9144100360	Wengue Ravenna 06x2,75x1,85 2L

HDF BP LINHA GRANN



Cinamomo Compensato Galiano

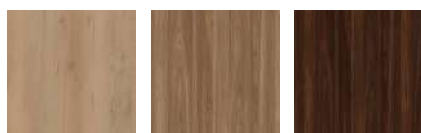

Faia Louro Freijó Louro Preto

Código	Descrição
9144100413	Cinamomo 06x2,75x1,85 2L
9144100339	Compensato 06x2,75x1,85 2L
9144100417	Galiano 06x2,75x1,85 2L
9144100336	Faia 06x2,75x1,85 2L
9144100333	Louro Freijó 06x2,75x1,85 2L
9144100177	Louro Preto 06x2,75x1,85 2L

HDF BP LINHA MATT



Branco/Super White Ceramik Chumbo Millennial

Código	Descrição
9144100114	Branco 06x2,75x1,85 2L
9144100392	Branco Super White 06x2,75x1,85 1L
9144100372	Branco Super White 06x2,75x1,85 2L
9144100401	Ceramik 06x2,75x1,85 2L
9144100405	Chumbo 06x2,75x1,85 2L
9144100409	Millennial 06x2,75x1,85 2L

MDF BP LINHA TX

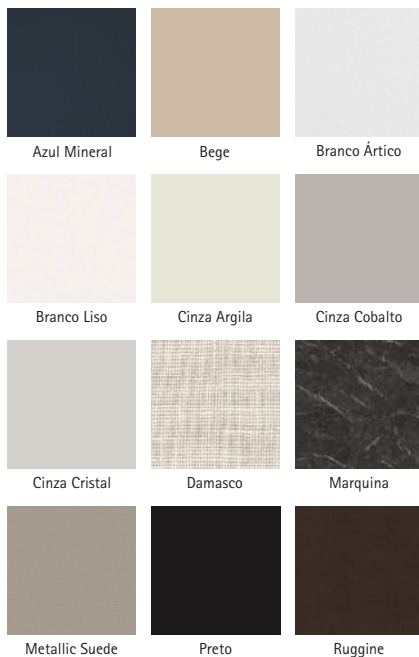

Código	Descrição
9144100050	Azul Mineral 15x2,75x1,85 2L
9144100076	Azul Mineral 18x2,75x1,85 2L
9144100087	Azul Mineral 25x2,75x1,85 2L
9144100088	Bege 9x2,75x1,85 2L
9144100067	Bege 15x2,75x1,85 2L
9144100175	Bege 18x2,75x1,85 1L
9144100068	Bege 18x2,75x1,85 2L
9144100157	Bege 25x2,75x1,85 2L
9144100004	Branco Ártico 09x2,75x1,85 1L
9144100005	Branco Ártico 09x2,75x1,85 2L
9144100008	Branco Ártico 15x2,75x1,85 1L
9144100009	Branco Ártico 15x2,75x1,85 2L
9144100010	Branco Ártico 18x2,75x1,85 1L
9144100001	Branco Ártico 18x2,75x1,85 2L
9144100030	Branco Ártico 25x2,75x1,85 1L
9144100011	Branco Ártico 25x2,75x1,85 2L
9144100200	Branco Liso 09x2,75x1,85 2L
9144100020	Branco Liso 15x2,75x1,85 2L
9144100014	Branco Liso 18x2,75x1,85 2L
9144100201	Branco Liso 25x2,75x1,85 2L
9144100142	Cinza Argila 15x2,75x1,85 2L
9144100143	Cinza Argila 18x2,75x1,85 2L
9144100208	Cinza Argila 25x2,75x1,85 2L
9144121078	Cinza Cobalto 09x2,75x1,85 2L
9144100168	Cinza Cobalto 15x2,75x1,85 2L

Código	Descrição
9144100189	Cinza Cobalto 18x2,75x1,85 1L
9144100169	Cinza Cobalto 18x2,75x1,85 2L
1680340007	Cinza Cobalto 25x2,75x1,85 2L
9144100238	Cinza Cristal 09x2,75x1,85 2L
9144100055	Cinza Cristal 15x2,75x1,85 2L
9144100090	Cinza Cristal 18x2,75x1,85 1L
9144100056	Cinza Cristal 18x2,75x1,85 2L
9144100091	Cinza Cristal 25x2,75x1,85 2L
9144100097	Damasco 15x2,75x1,85 2L
9144100149	Damasco 18x2,75x1,85 2L
9144100398	Marquina 15x2,75x1,85 2L
9144100399	Marquina 18x2,75x1,85 2L
9144100400	Marquina 25x2,75x1,85 2L
9144100235	Metallic Suede 15x2,75x1,85 2L
9144100225	Metallic Suede 18x2,75x1,85 2L
9144100257	Metallic Suede 25x2,75x1,85 2L
9144100075	Preto 09x2,75x1,85 1L
9144100164	Preto 09x2,75x1,85 2L
9144100045	Preto 15x2,75x1,85 2L
9141200713	Preto 18x2,75x1,85 1L
9144100046	Preto 18x2,75x1,85 2L
9144100241	Preto 25x2,75x1,85 2L
9144100331	Ruggine 15x2,75x1,85 2L
9144100332	Ruggine 18x2,75x1,85 2L
9144100362	Ruggine 25x2,75x1,85 2L

MDF BP LINHA VEL



Código	Descrição
9144100230	Azul 15x2,75x1,85 2L
9144100223	Azul 18x2,75x1,85 2L
9144100258	Azul 25x2,75x1,85 2L
9144100219	Branco 15x2,75x1,85 2L
9144100220	Branco 18x2,75x1,85 2L
9144100277	Branco 25x2,75x1,85 2L
9144100343	Calcare 15x2,75x1,85 2L
9144100344	Calcare 18x2,75x1,85 2L
9144100366	Calcare 25x2,75x1,85 2L
9144100211	Chiaro 15x2,75x1,85 2L
9144100212	Chiaro 18x2,75x1,85 2L
9144100286	Chiaro 25x2,75x1,85 2L
9144100231	Cinza Cobalto 15x2,75x1,85 2L
9144100221	Cinza cobalto 18x2,75x1,85 2L
9144100163	Cinza cobalto 25x2,75x1,85 2L

Código	Descrição
9144100620	Denim 06x2,75x1,85 2L
9144100621	Denim 15x2,75x1,85 2L
9144100622	Denim 18x2,75x1,85 2L
9144100623	Denim 25x2,75x1,85 2L
9144100228	Linen grigio 15x2,75x1,85 2L
9144100226	Linen grigio 18x2,75x1,85 2L
9144100287	Linen grigio 25x2,75x1,85 2L
9144100346	Nude 15x2,75x1,85 2L
9144100347	Nude 18x2,75x1,85 2L
9144100361	Nude 25x2,75x1,85 2L
9144100422	Panamá 15x2,75x1,85 2L
9144100423	Panamá 18x2,75x1,85 2L
9144100424	Panamá 25x2,75x1,85 2L
9144100078	Sky 18x2,75x1,85 2L

MDF BP LINHA TATTO



Amantea Barrique Baumkuchen

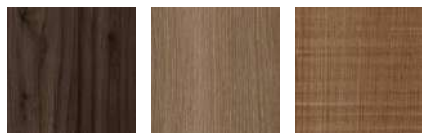

Castaine Gengibre Peroba



Provence

Código	Descrição
9144100252	Amantea 15x2,75x1,85 2L
9144100253	Amantea 18x2,75x1,85 2L
9144100249	Amantea 25x2,75x1,85 2L
9144100266	Barrique 15x2,75x1,85 2L
9144100267	Barrique 18x2,75x1,85 2L
9140300094	Barrique 25x2,75x1,85 2L
9144100269	Baumkuchen 15x2,75x1,85 2L
9144100270	Baumkuchen 18x2,75x1,85 2L
9140301558	Baumkuchen 25x2,75x1,85 2L
9144100260	Castaine 15x2,75x1,85 2L
9144100261	Castaine 18x2,75x1,85 2L

Código	Descrição
9141200019	Castaine 25x2,75x1,85 2L
9144100217	Gengibre 15x2,75x1,85 2L
9144100218	Gengibre 18x2,75x1,85 2L
9144100322	Gengibre 25x2,75x1,85 2L
9144100425	Peroba 09x2,75x1,85 1L
9144100198	Peroba 15x2,75x1,85 2L
9144100199	Peroba 18x2,75x1,85 2L
9144100152	Peroba 25x2,75x1,85 2L
9144100282	Provence 15x2,75x1,85 2L
9144100283	Provence 18x2,75x1,85 2L
9144100314	Provence 25x2,75x1,85 2L

MDF BP LINHA MATT



Super White/Branco Ceramik



Chumbo Millennial

Código	Descrição
9144100115	Branco 15x2,75x1,85 2L
9144121077	Branco 18x2,75x1,85 2L
9144100307	Branco 25x2,75x1,85 2L
9144100370	Branco Super White 15x2,75x1,85 2L
9144100371	Branco Super White 18x2,75x1,85 2L
9144100426	Branco Super White 25x2,75x1,85 2L
9144100402	Ceramik 15x2,75x1,85 2L
9144100403	Ceramik 18x2,75x1,85 2L

Código	Descrição
9144100404	Ceramik 25x2,75x1,85 2L
9144100406	Chumbo 15x2,75x1,85 2L
9144100407	Chumbo 18x2,75x1,85 2L
9144100408	Chumbo 25x2,75x1,85 2L
9144100410	Millennial 15x2,75x1,85 2L
9144100411	Millennial 18x2,75x1,85 2L
9144100412	Millennial 25x2,75x1,85 2L

MDF BP LINHA RUST



Argento Nero

Código	Descrição
9144100352	Argento 15x2,75x1,85 2L
9144100353	Argento 18x2,75x1,85 2L
9144100379	Argento 25x2,75x1,85 2L
9144100349	Nero 15x2,75x1,85 2L
9144100350	Nero 18x2,75x1,85 2L
9144100363	Nero 25x2,75x1,85 2L

MDF BP LINHA DESIGN



Branco Carvalho Treviso Nugal Malaga



Nugal Turin Preto

Código	Descrição
9144100070	Branco 15x2,75x1,85 2L
9144100071	Branco 18x2,75x1,85 2L
9144100170	Branco 25x2,75x1,85 2L
9144100393	Carvalho Treviso 09x2,75x1,85 1L
9144100146	Carvalho Treviso 15x2,75x1,85 2L
9144100147	Carvalho Treviso 18x2,75x1,85 2L
9144100245	Carvalho Treviso 25x2,75x1,85 2L
9144100107	Nugal Malaga 15x2,75x1,85 2L

Código	Descrição
9144100110	Nugal Malaga 18x2,75x1,85 2L
9144100158	Nugal Malaga 25x2,75x1,85 2L
9144100112	Nugal Turin 15x2,75x1,85 2L
9144100113	Nugal Turin 18x2,75x1,85 2L
9144100139	Preto 15x2,75x1,85 2L
9144100140	Preto 18x2,75x1,85 2L
9144100308	Preto 25x2,75x1,85 2L

MDF BP LINHA PORO



Código	Descrição
9144100099	Carvalho Atenas 15x2,75x1,85 2L
9144100100	Carvalho Atenas 18x2,75x1,85 2L
9144100315	Carvalho Atenas 25x2,75 x1,85 2L
9144100124	Carvalho Nice 15x2,75x1,85 2L
9144100125	Carvalho Nice 18x2,75x1,85 2L
9144100237	Carvalho Nice 25x2,75x1,85 2L
9144100064	Carvalho Treviso 15x2,75x1,85 2L
9144100065	Carvalho Treviso 18x2,75x1,85 2L
9144100052	Frassino Almendra 15x2,75x1,85 2L
9144100053	Frassino Almendra 18x2,75x1,85 2L
9144100373	Frassino Almendra 25x2,75x1,85 2L
9144100118	Frassino Whiskey 15x2,75x1,85 2L
9144100119	Frassino Whiskey 18x2,75x1,85 2L
9144100323	Frassino Whiskey 25x2,75x1,85 2L
9144100136	Italian Noce 15x2,75x1,85 2L
9144100137	Italian Noce 18x2,75x1,85 2L

Código	Descrição
9144100207	Italian Noce 25x2,75x1,85 2L
9144100048	Maple 15x2,75x1,85 2L
9144100049	Maple 18x2,75x1,85 2L
9144100244	Maple 25x2,75x1,85 2L
9144100061	Nogal Sevilha 15x2,75x1,85 2L
9144100062	Nogal Sevilha 18x2,75x1,85 2L
9144100174	Nogal Sevilha 25x2,75x1,85 2L
9144100358	Palissandro Ártico 09x2,75x1,85 2L
9144100042	Palissandro Ártico 15x2,75x1,85 2L
9144100043	Palissandro Ártico 18x2,75x1,85 2L
9144100105	Wengue Ravenna 15x2,75x1,85 2L
9144100106	Wengue Ravenna 18x2,75x1,85 2L
9144100240	Wengue Ravenna 25x2,75x1,85 2L
9144100144	Wengue Valência 15x2,75x1,85 2L
9144100154	Wengue Valência 18x2,75x1,85 2L
9144100317	Wengue Valência 25x2,75x1,85 2L

MDF BP GRANN



Código	Descrição
9144100628	Cacao 06x2,75x1,85 2L
9144100629	Cacao 15x2,75x1,85 2L
9144100630	Cacao 18x2,75x1,85 2L
9144100631	Cacao 25x2,75x1,85 2L
9144100414	Cinamomo 15x2,75x1,85 2L
9144100415	Cinamomo 18x2,75x1,85 2L
9144100416	Cinamomo 25x2,75x1,85 2L
9144100340	Compensato 15x2,75x1,85 2L
9144100341	Compensato 18x2,75x1,85 2L
9144100337	Faia 15x2,75x1,85 2L
9144100338	Faia 18x2,75x1,85 2L
9144100436	Faia 25x2,75x1,85 2L
9144100418	Galiano 15x2,75x1,85 2L
9144100419	Galiano 18x2,75x1,85 2L
9144100420	Galiano 25x2,75x1,85 2L

Código	Descrição
9144100624	Griseo 06x2,75x1,85 2L
9144100625	Griseo 15x2,75x1,85 2L
9144100626	Griseo 18x2,75x1,85 2L
9144100627	Griseo 25x2,75x1,85 2L
9144100334	Louro Freijó 15x2,75x1,85 2L
9144100335	Louro Freijó 18x2,75x1,85 2L
9144100380	Louro Freijó 25x2,75x1,85 2L
9144100178	Louro Preto 15x2,75x1,85 2L
9144100179	Louro Preto 18x2,75x1,85 2L
9144100396	Louro Preto 25x2,75x1,85 2L
9144100608	Solanum 06x2,75x1,85 2L
9144100609	Solanum 15x2,75x1,85 2L
9144100610	Solanum 18x2,75x1,85 2L
9144100611	Solanum 25x2,75x1,85 2L

MDF BP LINHA MICRO

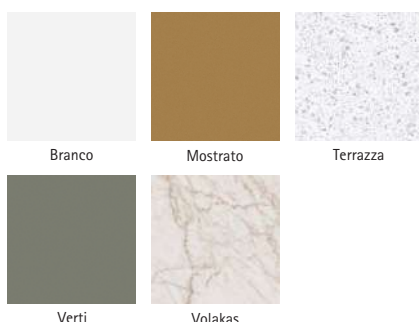

Código	Descrição
9144100600	Branco 06x2,75x1,85 2L
9144100601	Branco 15x2,75x1,85 2L
9144100602	Branco 18x2,75x1,85 2L
9144100603	Branco 25x2,75x1,85 2L
9144100632	Mostrato 06x2,75x1,85 2L
9144100633	Mostrato 15x2,75x1,85 2L
9144100634	Mostrato 18x2,75x1,85 2L
9144100635	Mostrato 25x2,75x1,85 2L
9144100616	Terrazza 06x2,75x1,85 2L
9144100617	Terrazza 15x2,75x1,85 2L

Código	Descrição
9144100618	Terrazza 18x2,75x1,85 2L
9144100619	Terrazza 25x2,75x1,85 2L
9144100612	Verti 06x2,75x1,85 2L
9144100613	Verti 15x2,75x1,85 2L
9144100614	Verti 18x2,75x1,85 2L
9144100615	Verti 25x2,75x1,85 2L
9144100604	Volakas 06x2,75x1,85 2L
9144100605	Volakas 15x2,75x1,85 2L
9144100606	Volakas 18x2,75x1,85 2L
9144100607	Volakas 25x2,75x1,85 2L

MDF CANALETADO



Branco Louro Freijó Preto TX Modelo Canaletado

Código	Descrição
9144100033	Branco Tx 18x2,75x1,85 1L Entre Friso 9cm
9144100450	Branco Tx 18x2,75x1,85 2L Entre Friso 9cm
9144100439	Louro Freijó 18x2,75x1,85 2L
9144100304	Preto Tx 18x2,75x1,85 2L Entre Friso 9cm

MDF CRU



Código	Descrição
9144100025	Berneck 09x2,75x1,85
9144100017	Berneck 12x2,75x1,85
9144100015	Berneck 15x2,75x1,85
9144100077	Berneck 15x2,75x2,20
9144100012	Berneck 18x2,75x1,85
9144100036	Berneck 22x2,75x1,90
9144100022	Berneck 25x2,75x1,85

Código	Descrição
9140300048	Eucalipto Duratex 35x2,75x1,84
9140300068	Eucalipto Duratex 20x2,75x1,90
9140301190	Eucalipto Duratex 18x2,75x1,84
9140300544	Eucalipto Duratex 15x2,75x1,84
9140300025	Duratex 09x2,75x1,84
9141200102	Arauco 30x2,75x1,85

MDF PLUS



Branco Ártico Cru

Código	Descrição
9140300084	Branco Ártico 09x2,75x1,85 2L
9140301503	Branco Ártico 15x2,75x1,85 2L
9140300537	Branco Ártico 18x2,75x1,85 2L
9140300538	Branco Ártico 25x2,75x1,85 2L
9144100153	Cru 09x2,75x1,85

Código	Descrição
9144100167	Cru 12x2,75x1,85
9144100156	Cru 15x2,75x1,85
9144100355	Cru 15x2,75x2,20
9142000053	Cru 18x2,75x1,85
9140300643	Cru 25x2,75x1,85

*A linha Plus garante mais resistência à umidade

EUCADUR/EUCAPLAC LISO



Eucadur Eucaplac Branco

Código	Descrição
9140300117	Eucadur Liso 03x2,75x2,13 Eucatex
9140301206	Eucadur Liso 2,5x2,44x1,22 Eucatex
9140300100	Eucadur Liso 2,5x2,75x2,13 Eucatex
9140300964	Eucaplac Bianco Liso 2,5x2,75x2,13 1L Eucatex

FITAS DE BORDA



Código	Descrição	Código	Descrição
2001002611	Amantea Tatto 22x0,40mm	9108001511	Chiaro Vel 45x0,40mm
2001002986	Amantea Tatto 45x0,40mm	9108001509	Chiaro Vel 64x0,40mm
9108001471	Amantea Tatto 64x0,45mm	9108448744	Cinamomo Grann 22x0,45mm
9108001475	Argento Rust 22x0,45mm	9108448745	Cinamomo Grann 45x0,45mm
9108001476	Argento Rust 45x0,45mm	9108448746	Cinamomo Grann 64x0,45mm
9108001477	Argento Rust 64x0,45mm	9108001462	Compensato Grann 22x0,45mm
2001002433	Azul Tx 22x0,45mm	9108001463	Compensato Grann 45x0,45mm
2001002436	Azul Tx 45x0,45mm	9108001464	Compensato Grann 64x0,45mm
2001002971	Azul Vel 22x0,45mm	2001002451	Cinza Argila Tx 22x0,45mm
9108001520	Azul Vel 45x0,45mm	2001002454	Cinza Argila Tx 45x0,45mm
9108445593	Azul Vel 64x0,45mm	2001002455	Cinza Argila Tx 64x0,45mm
9108001529	Barrique Tatto 22x0,45mm	9108001860	Cinza Cobalto 22x0,40mm
2001002383	Barrique Tatto 29x0,45mm	9108001519	Cinza Cobalto Vel 22x0,45mm
9108001530	Barrique Tatto 45x0,45mm	9108001518	Cinza Cobalto Vel 45x0,40mm
9108001525	Baumkuchen Tatto 22x0,45mm	9108001859	Cinza Cobalto 45x0,40mm
9108001532	Baumkuchen Tatto 45x0,45mm	2001002452	Cinza Cobalto Tx 64x0,45mm
9108001541	Baumkuchen Tatto 64x0,45mm	2001002982	Cinza Cobalto Vel 64x0,45mm
2001002518	Branco Design 22x0,40mm	2001002456	Cinza Cristal Tx 19x0,45mm
2001002519	Branco Design 45x0,45mm	2001002457	Cinza Cristal Tx 22x0,45mm
2001002876	Branco Design 64x0,45mm	2001002458	Cinza Cristal Tx 29x0,45mm
2001003629	Branco Super White 22x0,45mm	2001002460	Cinza Cristal Tx 45x0,45mm
2001003630	Branco Super White 45x0,45mm	2001002459	Cinza Cristal Tx 64x0,45mm
2001004165	Branco Super White 64x0,45mm	2001002493	Damasco Tx 22x0,40mm
9108001516	Branco Vel 22x0,40mm	2001002494	Damasco Tx 45x0,40mm
9108001517	Branco Vel 45x0,40mm	2001002746	Dakota Design 22x0,45mm
9108001501	Branco Vel 64x0,45mm	2001002747	Dakota Design 45x0,45mm
9108002143	Branco Liso/matt 22x0,45mm	2001002749	Dakota Design 64x0,45mm
9108005459	Branco Liso/matt 45x0,40mm	2001002394	Denim 45x0,45mm
9108005460	Branco Liso/matt 64x0,45mm	9108001458	Faia Grann 22x0,45mm
9108002003	Branco Liso/matt 100x0,40mm	9108001460	Faia Grann 45x0,45mm
2001002438	Tx Branco 19x0,45mm	9108001461	Faia Grann 64x0,45mm
2001003000	Tx Branco 19x0,45mm	9108002702	Frassino Almendra 22x0,45mm
2001002439	Tx Branco 22x0,45mm	9108001018	Frassino Almendra 64x0,45mm
2001004140	Tx Branco 22x0,45mm	9108001537	Frassino Lis 22x0,45mm
2001002614	Tx Branco 22x1,00mm	9108001536	Frassino Lis 45x0,45mm
2001002441	Tx Branco 29x0,45mm	9108001538	Frassino Lis 64x0,45mm
2001002449	Tx Branco 29x1,00mm	9108001535	Frassino Stone 22x0,45mm
2001002440	Tx Branco 35x0,45mm	9108001534	Frassino Stone 45x0,45mm
2001002442	Tx Branco 45x0,45mm	9108001020	Frassino Stone 64x0,45mm
9108450568	Tx Branco 64x0,45mm	9108001212	Frassino Whiskey 22x0,45mm
2001002443	Tx Branco 100x0,45mm	9108001213	Frassino Whiskey 45x0,45mm
2001002305	Cacau 22x0,45mm	9108001214	Frassino Whiskey 64x0,45mm
9108001043	Cacau 45x0,45mm	9108448750	Galiano Grann 22x0,45mm
9108448175	Cacau 64x0,45mm	9108448751	Galiano Grann 45x0,45mm
9108001465	Calcare Vel 22x0,45mm	9108448752	Galiano Grann 64x0,45mm
9108001466	Calcare Vel 45x0,45mm	9108001512	Gengibre Tatto 22x0,45mm
9108001467	Calcare Vel 64x0,45mm	9108001513	Gengibre Tatto 45x0,40mm
2001002421	Carvalho Nice 22x0,45mm	9108001521	Gengibre Tatto 64x0,40mm
2001002424	Carvalho Nice 45x0,40mm	9108445592	Griseo 22x0,45mm
2001002422	Carvalho Nice 64x0,40mm	2001002752	Griseo 45x0,45mm
2001002789	Carvalho Treviso Design 22x0,40mm	2001004145	Griseo 64x0,45mm
2001002790	Carvalho Treviso Design 45x0,40mm	2001002409	Italian Noce 22x0,40mm
2001002313	Carvalho Treviso Poro 22x0,40mm	2001002412	Italian Noce 45x0,40mm
2001002316	Carvalho Treviso Poro 45x0,40mm	2001002993	Italian Noce 64x0,40mm
2001002329	Carvalho Treviso Poro 64x0,40mm	2001002970	Linen Grigio Vel 22x0,45mm
9108001524	Castaine Tatto 22x0,45mm	2001002968	Linen Grigio Vel 45x0,45mm
2001002994	Castaine Tatto 45x0,45mm	2001002328	Linen Grigio Vel 64x0,45mm
9108001303	Castaine Tatto 64x0,45mm	2001002340	Linen Grigio Vel 100x0,45mm
9108448756	Ceramik Matt 22x0,45mm	9108001455	Louro Freijó Grann 22x0,45mm
9108448757	Ceramik Matt 45x0,45mm	9108001456	Louro Freijó Grann 45x0,45mm
9108001510	Chiaro Vel 22x0,40mm	9108001457	Louro Freijó Grann 64x0,45mm

FITAS DE BORDA

Código	Descrição	Código	Descrição
2001002330	Louro Preto 22x0,45mm	2001002464	Preto Tatto 29x0,45mm
2001002333	Louro Preto 45x0,45mm	2001002462	Preto Tx 19x0,45mm
2001002307	Louro Preto 64x0,45mm	2001002463	Preto Tx 22x0,45mm
2001002427	Maple Tx 22x0,45mm	2001002465	Preto Tx 45x0,45mm
2001002430	Maple Tx 45x0,45mm	2001002467	Preto Tx 100x0,45mm
9108448747	Chumbo Matt 22x0,45mm	9108001527	Provence 22x0,45mm
9108448748	Chumbo Matt 45x0,45mm	9108001528	Provence 45x0,45mm
9108448749	Chumbo Matt 64x0,45mm	9108001452	Ruggine Tx 22x0,45mm
2001002301	Marfim Florença 22x0,40mm	9108001453	Ruggine Tx 45x0,45mm
2001002304	Marfim Florença 45x0,40mm	9108001454	Ruggine Tx 64x0,45mm
9108448759	Millennial Matt 22x0,45mm	2001002842	Salina Tatto 22x0,45mm
9108448760	Millennial Matt 45x0,45mm	2001002855	Salina Tatto 45x0,45mm
9108448761	Millennial Matt 64x0,45mm	2001003246	Salina Tatto 64x0,45mm
9108000109	Mostrato 22x0,45mm	2001002841	Savana Tatto 22x0,45mm
2001002523	Mostrato 45x0,45mm	2001002854	Savana Tatto 45x0,45mm
9108000102	Mostrato 64x0,45mm	2001003164	Savana Tatto 64x0,45mm
9108001409	Nero Rust 22x0,45mm	2001002390	Solanum 22x0,45mm
9108001410	Nero Rust 45x0,45mm	2001004234	Solanum 45x0,45mm
9108001451	Nero Rust 64x0,45mm	2001002437	Solanum 64x0,45mm
2001002371	Nogal Malaga Design 22x0,40mm	9108001057	Sky Vel 22x0,45mm
2001002374	Nogal Malaga Design 45x0,45mm	9108001058	Sky Vel 45x0,45mm
2001002978	Nogal Malaga Design 64x0,45mm	2001002526	Terrazza 64x0,45mm
2001002403	Nogal Sevilha 22x0,40mm	2001002527	Terrazza 22x0,45mm
2001002405	Nogal Sevilha 45x0,45mm	2001002524	Terrazza 45x0,45mm
2001002610	Nogal Sevilha 64x0,45mm	2001002522	Verti 22x0,45mm
2001002407	Nogal Sevilha 100x0,40mm	2001002606	Verti 45x0,45mm
2001002469	Noce Macchiato 22x0,45mm	2001002384	Verti 64x0,45mm
2001002472	Noce Macchiato 45x0,40mm	2001002605	Volakas 22x0,45mm
2001002500	Noce Macchiato 64x0,40mm	2001002450	Volakas 45x0,45mm
9108001468	Nude Vel 22x0,45mm	2001002751	Volakas 64x0,45mm
9108001469	Nude Vel 45x0,45mm	2001002379	Wengue Ravenna 22x0,40mm
9108001470	Nude Vel 64x0,45mm	2001002618	Wengue Ravenna 35x0,45mm
9108448762	Panamá Vel 22x0,45mm	2001002382	Wengue Ravenna 45x0,40mm
9108448763	Panamá Vel 45x0,45mm	2001002501	Wengue Ravenna 64x0,40mm
9108448764	Panamá Vel 64x0,45mm	2001002385	Wengue Valencia Poro 22x0,40mm
2001002843	Peroba Tatto 22x0,45mm	2001002388	Wengue Valencia Poro 45x0,40mm
2001002856	Peroba Tatto 45x0,45mm	2001002952	Wengue Valencia Poro 64x0,45mm
2001002906	Peroba 64x0,45mm	9108001523	Wood 22x0,45mm
2001002492	Preto Design 22x0,45mm	9108001522	Wood 45x0,45mm
2001002476	Preto Design 45x0,40mm	2001002324	Wood 64x0,45mm
2001002555	Preto Design 64x0,45mm		



TAPA FUROS

Código	Descrição
2001007113	Amantea Tatto 13mm
2001007114	Amantea Tatto 19mm
2001003114	Argento Rust 13mm
2001000639	Azul Arauco 13mm
2001001754	Azul Vel 13mm
2001000931	Azul Tx 17mm
2001007115	Barrique Tatto 13mm
2001007116	Barrique Tatto 19mm
2001007111	Baumkuchen Tatto 13mm
2001007112	Baumkuchen Tatto 19mm
2001000726	Bege Maple 13mm
2001003034	Bege Maple 19mm
2001003440	Branco 10mm
2001002592	Branco Design 13mm
2001001412	Branco Liso 17mm
6021175	Branco Liso 18mm
2001000878	Branco Liso 19mm
2001001739	Branco Liso Branco 19mm
2001001009	Branco Liso Branco 19mm
2001000856	Branco MD Liso 19mm
2001002639	Branco Brilho 19mm
2001001401	Branco Liso Brilho 13mm
2001003933	Branco Liso Brilho 65mm
2001000499	Branco Liso Fosco 13mm
2001003853	Branco Liso Fosco 17mm
2001001487	Branco Liso Fosco 17mm
2001000873	Branco Liso Fosco 19mm
2001003200	Branco Supremo 13mm
2001003199	Branco Supremo 19mm
2001000992	Branco Tx 12mm
2001000583	Branco Tx 13mm
2001000494	Branco Tx 17mm
2001001019	Branco Tx 19mm
2001003136	Branco Vel 13mm
2001003137	Branco Vel 19mm
2001003060	Calcare Vel 13mm
2001003789	Cacau 18mm
2001001825	Carvalho Nice 13mm
2001001827	Carvalho Nice 19mm
2001001853	Carvalho Treviso 13mm

Código	Descrição
2001000703	Carvalho Treviso 19mm
2001003121	Castaine Tatto 13mm
2001003405	Chiaro Vel 19mm
2001002000	Chumbo Matt 13mm
2001003820	Cinamomo 10mm
2001003802	Cinamomo 18mm
2001003805	Cinamomo 30mm
2001003827	Cinamomo Castanho 10mm
2001003829	Cinamomo Castanho 18mm
2001003825	Cinamomo Castanho 30mm
2001003826	Cinamomo Natural 10mm
2001003828	Cinamomo Natural 18mm
2001001752	Cinamomo Grann 19mm
2001002850	Cinza BT 19mm
2001004184	Cinza Cobalto 19mm
2001003108	Cinza Cobalto 19mm
2001007054	Cinza Cobalto Tx 13mm
2001007121	Cinza Cobalto Vel 13mm
2001003652	Cinza Cobalto Vel 19mm
2001000818	Cinza Cristal Tx 19mm
2001000638	Cinza Cristal Tx 13mm
2001003831	Cinza Pebble 17mm
2001003573	Cinza Vitar 13mm
2001002796	Cinza Vitar 19mm
2001004147	Compensato Grann 13mm
2001001815	Damasco 13mm
2001002781	Dakota Design 13mm
2001002560	Dakota Design 19mm
2001001168	Faia 13mm
9812080281	Frassino Almendra 19mm
2001007089	Frassino Lis 13mm
2001007081	Frassino Lis 19mm
2001007656	Frassino Stone 13mm
2001007657	Frassino Stone 19mm
2001001172	Frassino Whiskey 13mm
2001001139	Frassino Whiskey 19mm
2001003230	Gengibre Tatto 13mm
2001002961	Gengibre Tatto 13mm
2001003231	Gengibre Tatto 19mm
2001004185	Gengibre Tatto 19mm
2001003855	Galiano 13mm
2001001839	Italian Noce 17mm
2001001834	Italian Noce 19mm
2001002959	Linen Grigio Vel 13mm
2001002960	Linen Grigio Vel 19mm
2001003944	Louro Freijó Grann 13mm
2001003342	Louro Freijó Grann 13mm
2001003262	Louro Freijó Grann 19mm

Código	Descrição
2001003677	Louro Freijó Grann 19mm
2001003262	Louro Freijó Grann 19mm
2001003622	Louro Preto 13mm
9812080280	Louro Preto 19mm
2001002991	Metallic Suede 13mm
2001000971	Metallic Suede 17mm
2001004186	Metallic Suede 19mm
2001002992	Metallic Suede 19mm
2001001830	Marfim Florença 13mm
2001000480	Marfim Florença 17mm
2001004192	Millennial Matt 13mm
2001003739	Nero Rust 13mm
2001000993	Nogal Malaga 13mm
2001002837	Nogal Malaga 19mm
2001002594	Nogal Sevilha 13mm
2001002737	Nogal Sevilha 19mm
2001001843	Noce Macchiato 12mm
2001002863	Nude Vel 13mm
2001007035	Nude Vel 19mm
2001001817	Palissandro Ártico 13mm
2001001818	Palissandro Ártico 19mm
2001001838	Panamá Vel 13mm
2001002941	Peroba 13mm
2001002940	Peroba 19mm
2001001027	Preto 19mm
2001000990	Preto Brilho 19mm
2001000531	Preto Fosco 13mm
2001002554	Preto Fosco 19mm
2001000925	Preto Liso 17mm
2001001013	Preto Liso Auto Brilho 19mm
2001000530	Preto Liso Brilho 13mm
2001003126	Preto Onix 19mm
2001000640	Preto Tx 13mm
2001000893	Preto Tx 17mm
2001000708	Preto Tx 19mm
2001007117	Provence Tatto 13mm
2001007118	Provence Tatto 19mm
2001003047	Ruggine Tx 13mm
2001004183	Ruggine Tx 19mm
2001002945	Salina Tatto 13mm
2001002944	Salina Tatto 19mm
2001002947	Savana Tatto 13mm
2001004187	Savana Tatto 19mm
2001001127	Sky Vel 13mm
2001001835	Wengue Ravenna 13mm
2001001822	Wengue Valencia 13mm
2001002769	Wood Tatto 13mm
2001002772	Wood Tatto 19mm





ABRASIVOS

DISCO DE CORTE SUPER AR312



Código	Descrição	Emb.
9139126009	300x3,2x25,40	UN
9139126889	Nº7 177,8x3,0x22,22	UN
9139126896	Nº9 228,6x3,0x22,22	UN

DISCO DE FERRO A36QB32



Código	Dimensões	Emb.
9124210005	Nº 4,5 - 114,3x3,2x22,2	UN
9124210012	Nº 07 - 177,8x3,2x22,2	UN
9124210029	Nº 09 - 228,6x3,2x22,2	UN
9124210043	Nº 12 - 304,8x3,2x25,4	UN

DISCO REFRAATÁRIO CRS14



Código	Descrição	Emb.
9124210074	Nº 09 - 228,6x3,2x22,2	UN

DISCO DE DESBASTE A82RB



Código	Dimensões	Emb.
9124210104	Nº 4,5 - 114,3x6,4x22,2	UN

DISCO DE CORTE FINO - METAL/INOX



Código	Descrição	Emb.
9139126865	4.1/2x1,0mmx7/8	UN

DISCO DE CORTE MULTIMATERIAL



Código	Descrição	Emb.
9106100059	4.1/2x1,0mmx7/8	UN

DISCO DE CORTE FINO PARA AÇO INOX



Código	Especificação	Emb.
1114095470	4.1/2"	UN
1114095487	7"	UN
1114095494	9"	UN

DISCO DIAMANTADO SEGMENTADO



Código	Descrição	Emb.
7095099919	110mmx20mm	UN

SERRA CIRCULAR CORTE RÁPIDO



Código	Dimensões	Emb.
7095036969	110x24Dx1,1x1,7mm	UN
7095036976	110x30Dx1,1x1,7mm	UN
7095036990	184x24Dx1,4x2,2mm	UN
7095037003	184x36Dx1,4x2,2mm	UN
7095037027	184x60Dx1,4x2,2mm	UN
7095037393	250x48Dx1,8x2,6mm	UN

SERRA CIRCULAR ESTACIONÁRIA PARA MADEIRA



Código	Dimensões	Emb.
7095037379	250mmx24D	UN
7095037386	250mmx36D	UN
7095037454	300mmx36D	UN

SERRA CIRCULAR PORTÁTIL PARA MADEIRA

Código	Dimensões	Emb.
7095036952	4,3/8x12Dx1,4x2,4	UN

ESPONJA ABRASIVA

Código	Descrição	Emb.
9139120095	Fina 120x98x13	UN
9139120076	Média 120x98x13	UN

MANTA GRAFITADA

Código	Dimensões	Emb.
9139126698	150x45000	UN
9139126728	200x45000	UN

LIXA A-237

Código	Grana	Tipo	Emb.
9139120412	80	F	UN
9139120443	150	F	UN

LIXA A-257

Código	Grana	Tipo	Emb.
9139120344	100	F	UN
9139120368	150	F	UN

LIXA A-275 SOFT-TOUCH

Código	Grana	Emb.
9139126392	P0220	UN
9139126394	P0320	UN
9139126393	P0400	UN

FOLHA 225X275MM LIXA A-219

Código	Grana	Tipo	Emb.
9139120603	80	F	UN
9139120610	100	F	UN
9139120627	120	F	UN
9139120634	150	F	UN
9139120641	180	F	UN
9139120658	220	F	UN

Código	Grana	Tipo	Emb.
9139120665	240	F	UN
9139120672	280	F	UN
9139120689	320	F	UN
9139120696	360	F	UN
9139120702	400	F	UN

FOLHA 225X275MM LIXA K-246

Código	Grana	Tipo	Emb.
9139120504	60	F	UN
9139120528	100	F	UN
9139120535	120	F	UN

DISCO LIXA 4.1/2 F-227

Código	Grana	Tipo	Emb.
9139121310	60	DS	UN
9139121327	80	DS	UN

DISCO LIXA 7 F-247



Código	Grana	Tipo	Emb.
9139121228	50	DS	UN
9139121235	60	DS	UN
9139121242	80	DS	UN

LIXA DISCO ROTO ORBI SCS BIANCO



Código	Grana	Dimensões	Emb.
9139122646	100	127mm 5 pol. c/furo	UN
9139122799	150	127mm 5 pol. c/furo	UN
9139122805	220	127mm 5 pol. c/furo	UN
9139122645	400	127mm 5 pol. c/furo	UN

DISCO 152MM LIXA A-275



Código	Grana	Tipo	Emb.
9139126328	80	DP	UN
9139126329	120	DP	UN
9139126330	150	DP	UN
9139126332	220	DP	UN
9139126334	320	DP	UN
9139126335	400	DP	UN

Código	Grana	Tipo	Emb.
9139120764	220	F	UN
9139120771	240	F	UN
9139120788	280	F	UN
9139120795	320	F	UN
9139120801	400	F	UN
9139120825	600	F	UN

ROLO LIXA R-269



Código	Grana	Dimensões	Emb.
9139122812	60	120x100000	UN
9139122928	60	150x100000	UN
9139122829	80	120x100000	UN
9139122935	80	150x100000	UN
9139122836	100	120x100000	UN
9139122942	100	150x100000	UN

Código	Grana	Dimensões	Emb.
9139122959	120	150x100000	UN
9139122850	150	120x100000	UN
9139122966	150	150x100000	UN
9139122867	180	120x100000	UN
9139122973	180	150x100000	UN
9139122980	220	150x100000	UN

ROLO LIXA G-125



Código	Grana	Dimensões	Emb.
9139121716	36	120x45000	UN
9139122218	36	610x23500	UN
9139121723	40	120x45000	UN
9139121822	40	150x45000	UN
9139121594	50	120x100000	UN
9139121730	50	120x45000	UN
9139122232	50	610x45000	UN
9139121600	60	120x100000	UN
9139121747	60	120x45000	UN
9139121662	60	150x100000	UN
9139122249	60	610x45000	UN
9139121617	80	120x100000	UN
9139121754	80	120x45000	UN
9139121679	80	150x100000	UN
9139122058	80	250x45000	UN

Código	Grana	Dimensões	Emb.
9139121624	100	120x100000	UN
9139121761	100	120x45000	UN
9139121686	100	150x100000	UN
9139122263	100	610x45000	UN
9139121631	120	120x100000	UN
9139121778	120	120x45000	UN
9139121693	120	150x100000	UN
9139122072	120	250x45000	UN
9139122270	120	610x45000	UN
9139121648	150	120x100000	UN
9139121785	150	120x45000	UN
9139122287	150	610x45000	UN
9139121792	180	120x45000	UN
9139120026	220	120x100000	UN
9139121808	220	120x45000	UN

ROLO LIXA 7 K-121/131

Código	Grana	Dimensões	Emb.
9139122463	k-121 60	120x45000	UN
9139122454	k-121 80	120x45000	UN
9139122539	k-121 80	150x45000	UN
9139122614	k-121 80	200x45000	UN
9139122690	k-121 80	250x45000	UN
9139122461	k-121 100	120x45000	UN
9139122622	k-121 100	250x45000	UN
9139122553	k-121 120	150x45000	UN
9139122492	k-131 36	150x45000	UN

Código	Grana	Dimensões	Emb.
9139122423	k-131 40	120x45000	UN
9139122508	k-131 40	150x45000	UN
9139122669	k-131 40	250x45000	UN
9139122430	k-131 50	120x45000	UN
9139122591	k-131 50	200x45000	UN
9139120079	k-131 60	120x45000	UN
9139122522	k-131 60	150x45000	UN
9139122607	k-131 60	200x45000	UN

ROLO LIXA S-422

Código	Grana	Dimensões	Emb.
9139121525	60	610x24100	UN

ROLO LIXA W-427

Código	Grana	Dimensões	Emb.
9139120003	P0100	120x45000	UN

ROLO LIXA PANO/ESPUMA

Código	Grana	Dimensões	Emb.
9139126346	400	115x10000mm	UN

LIXA ROLO ESPUMA SOFT-TOUCH

Código	Grana	Dimensões	Emb.
9139126292	220	115x25000mm	UN
9139126315	400	115x25000mm	UN

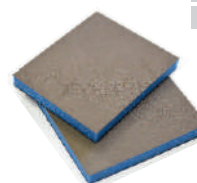
LIXA FLAP DISC R-822

Código	Grana	Tipo	Emb.
9139125012	40	DS	UN
9139125189	50	DS	UN
9139125017	60	DS	UN
9139125013	80	DS	UN
9139125001	120	DS	UN

LIXA BANDA LARGA PANO KA169

Código	Grana	Dimensões	Emb.
9139124916	P0050	1900x630	UN
9139124915	P0060	1900x930	UN
9139124933	P0080	1900x630	UN
9139124946	P0100	1900x630	UN
9139125745	P0150	2620x930	UN



LIXA BANDA LARGA PAPEL SESN



Código	Grana	Dimensões	Emb.
9139125073	P0220	2200x1250	UN
9139125660	P0220	2620x1250	UN
9139132607	P0220	2620x1315	UN
9139125947	P0220	2620x1350	UN
9139125387	P0220	2620x1380	UN
9139132608	P0220	2620x930	UN
9139125899	P0240	2620x1315	UN
9139132609	P0240	2620x1350	UN
9139126216	P0280	2620x1350	UN
9139132610	P0320	2620x1315	UN
9139120064	P0320	2620x1350	UN
9139125370	P0320	2620x1380	UN

Código	Grana	Dimensões	Emb.
9139132622	P0320	2620x930	UN
9139125677	P0400	2620x1250	UN
9139120043	P0400	2620x1315	UN
9139132612	P0400	2620x1350	UN
9139125747	P0400	2620x1380	UN
9139132623	P0400	2620x930	UN
9139126254	P0600	2620x1245	UN
9139125790	P0600	2620x1250	UN
9139120063	P0600	2620x1315	UN
9139126094	P0600	2620x1350	UN
9139132624	P0600	2620x930	UN

LIXA BANDA LARGA PAPEL CREF



Código	Grana	Dimensões	Emb.
9139125080	P0040	1900x630	UN
9139132538	P0040	1900x930	UN
9139132611	P0040	2620x1315	UN
9139125950	P0040	2620x1350	UN
9139132628	P0040	2620x930	UN
9139125295	P0050	1900x1130	UN
9139125097	P0050	1900x630	UN
9139132618	P0050	2620x1030	UN
9139122331	P0050	2620x1315	UN
9139132629	P0050	2620x930	UN
9139122348	P0060	1524x930	UN
9139125486	P0060	1740x1020	UN
9139132584	P0060	1900x1030	UN
9139132585	P0060	1900x1130	UN
9139132521	P0060	1900x630	UN
9139132613	P0060	1900x930	UN
9139120118	P0060	2200x1250	UN
9139132586	P0060	2620x1130	UN
9139132625	P0060	2620x1315	UN
9139132587	P0060	2620x1350	UN
9139132616	P0060	2620x930	UN
9139122355	P0080	1524x930	UN
9139132590	P0080	1900x1030	UN
9139120012	P0080	1900x1130	UN
9139132588	P0080	1900x630	UN
9139132589	P0080	1900x930	UN
9139125622	P0080	2620x1130	UN
9139125585	P0080	2620x1250	UN
9139132592	P0080	2620x1315	UN
9139132614	P0080	2620x1350	UN
9139132591	P0080	2620x930	UN
9139125783	P0100	1524x930	UN
9139124830	P0100	1900x1030	UN

Código	Grana	Dimensões	Emb.
9139120010	P0100	1900x1130	UN
9139132569	P0100	1900x630	UN
9139132593	P0100	1900x930	UN
9139125639	P0100	2620x1130	UN
9139132595	P0100	2620x1315	UN
9139132615	P0100	2620x1350	UN
9139125400	P0100	2620x1380	UN
9139132594	P0100	2620x930	UN
9139125257	P0120	1524x930	UN
9139122317	P0120	1740x1020	UN
9139132597	P0120	1900x1030	UN
9139120000	P0120	1900x1130	UN
9139132596	P0120	1900x630	UN
9139132309	P0120	1900x930	UN
9139125746	P0120	2200x1250	UN
9139132619	P0120	2620x1030	UN
9139125592	P0120	2620x1250	UN
9139132598	P0120	2620x1315	UN
9139132599	P0120	2620x1350	UN
9139132617	P0120	2620x930	UN
9139132601	P0150	1900x1030	UN
9139132477	P0150	1900x930	UN
9139132620	P0150	2620x1030	UN
9139125615	P0150	2620x1130	UN
9139125608	P0150	2620x1250	UN
9139132603	P0150	2620x1315	UN
9139132604	P0150	2620x1350	UN
9139125394	P0150	2620x1380	UN
9139132602	P0150	2620x930	UN
9139122393	P0180	2620x1315	UN
9139125462	P0180	2620x1350	UN
9139125363	P0180	2620x930	UN

LIXA BANDA LARGA NF1 102XS



Código	Grana	Dimensões	Emb.
9139124816	P0060	1900x1030	UN
9139124823	P0080	1900x1030	UN
9139100004	P0100	2620x1130	UN
9139125653	P0150	2620x1130	UN
9139125288	P0220	2620x1350	UN

LIXA CINTA PANO JA 165



Código	Grana	Dimensões	Emb.
9139132002	P0100	2520x75	UN
9139132057	P0150	2520x75	UN
9139132101	P0220	2520x75	UN
9139132156	P0400	2520x75	UN

LIXA CINTA PANO KA169

Código	Grana	Dimensões	Emb.	Código	Grana	Dimensões	Emb.
9139122638	36	533x75mm	UN	9139122751	80	610x75mm	UN
9139120092	36	610x75mm	UN	9139132453	80	6700x120 mm	UN
9139122775	36	610x100mm	UN	9139132627	80	6250x120mm	UN
9139132422	40	610x75mm	UN	9139124557	80	6300x140mm	UN
9139132626	40	6250x120mm	UN	9139124595	80	6600x140mm	UN
9139122706	50	533x75mm	UN	9139122744	100	533x75 mm	UN
9139122720	50	610x75mm	UN	9139122577	100	610x75 mm	UN
9139122676	50	610x100mm	UN	9139122462	100	610x100 mm	UN
9139124540	50	6300x140	UN	9139126131	100	2520x75	UN
9139124588	50	6600x140	UN	9139124564	100	6300x140	UN
9139122768	60	533x75 mm	UN	9139124601	100	6600x140	UN
9139122652	60	610x100 mm	UN	9139132408	120	533x75 mm	UN
9139122447	60	610x75 mm	UN	9139121877	120	610x100 mm	UN
9139124571	60	6300x140mm	UN	9139123468	120	610x75 mm	UN
9139124618	60	6600x140mm	UN	9139132415	150	533x75 mm	UN
9139132446	60	6700x120 mm	UN	9139122713	150	610x75 mm	UN
9139122737	80	533x75mm	UN	9139125752	220	2520x75	UN
9139122584	80	610x100mm	UN	9139132545	240	2520x75	UN

LIXA CINTA PAPEL CREF

Código	Grana	Dimensões	Emb.	Código	Grana	Dimensões	Emb.
9139124441	40	6300x140	UN	9139124472	80	6300x140	UN
9139124380	40	6600x140	UN	9139124410	80	6600x140	UN
9139124496	40	7200x140	UN	9139124526	80	7200x140	UN
9139124465	50	6300x140	UN	9139124489	100	6300x140	UN
9139124403	50	6600x140	UN	9139124434	100	6600x140	UN
9139124519	50	7200x140	UN	9139124533	100	7200x140	UN
9139124458	60	6300x140	UN	9139132255	150	1500x150	UN
9139124397	60	6600x140	UN	9139121884	150	7200x150	UN
9139124502	60	7200x140	UN	9139121907	220	7200x150	UN

LIXA CINTA PAPEL NF1102

Código	Grana	Dimensões	Emb.
9139123475	P0150	7200x120	UN
9139123499	P0180	7200x120	UN
9139123505	P0220	7200x120	UN



The image features a teal-tinted background with a diagonal split. The top-left portion shows a close-up of a person's hands wearing safety glasses and a white work glove, holding a tool. The bottom-left portion shows a pair of white work gloves and a clear plastic container. The right side of the image has a dark teal background with a fine, repeating geometric pattern. A dark teal rectangular box with a thin green border is centered in the lower half of the image, containing the text 'EPIS' in white, bold, sans-serif font, with a thin green horizontal line underneath it.

EPIS

LUVA TÁTIL BANHO PU PRETO



Código	Tamanho	Und.
2001007126	TAM P	PAR
2001007127	TAM M	PAR
2001007128	TAM G	PAR

LUVA COTTON BLACK PRETA



Código	Tamanho	Und.
2001007192	TAM U	PAR

LUVA BICOLOR SLIM LÁTEX/NEO AZUL E AMARELA



Código	Tamanho	Und.
2001007138	TAM 7	PAR
2001007139	TAM 8	PAR
2001007140	TAM 9	PAR
2001007141	TAM 10	PAR

LUVA GREEN



Código	Tamanho	Und.
2001007188	TAM G	PAR
2001007189	TAM GG	PAR
2001007187	TAM EEG	PAR

LUVA LÁTEX LARANJA



Código	Tamanho	Und.
2001007132	TAM 8	PAR
2001007133	TAM 9	PAR

PROTECTOR AUDITIVO



Código	Descrição	Und.
9999003139	TAM U Pomp Plus	UN
8999001554	TAM P Milenium	UN
8999009323	TAM M Milenium	UN

CREME PROTETOR DE PELE LUVA QUÍMICA G3



Código	Tamanho	Und.
2001007194	200g	UN
2001007077	200g - Bio.	UN

ÓCULOS DE SEGURANÇA



Código	Tamanho	Und.
8999000769	Incolor anti risco epitec	UN

SAPATO VAQUETA RELAX PRETO COM CADARÇO SOLA PU

Código	Tamanho	Und.	Código	Tamanho	Und.
2001007174	33	PAR	2001007181	40	PAR
2001007175	34	PAR	2001007182	41	PAR
2001007176	35	PAR	2001007183	42	PAR
2001007177	36	PAR	2001007184	43	PAR
2001007178	37	PAR	2001007185	44	PAR
2001007179	38	PAR	2001007186	45	PAR
2001007180	39	PAR			

SAPATO VAQUETA RELAX PRETO ELÁSTICO LATERAL SOLA PU

Código	Tamanho	Und.	Código	Tamanho	Und.
2001007148	33	PAR	2001007155	40	PAR
2001007149	34	PAR	2001007156	41	PAR
2001007150	35	PAR	2001007157	42	PAR
2001007151	36	PAR	2001007158	43	PAR
2001007152	37	PAR	2001007159	44	PAR
2001007153	38	PAR	2001007160	45	PAR
2001007154	39	PAR			

BOTINA VAQUETA RELAX PRETA COM ELÁSTICO LATERAL SOLA PU

Código	Tamanho	Und.	Código	Tamanho	Und.
2001007174	33	PAR	2001007181	40	PAR
2001007175	34	PAR	2001007182	41	PAR
2001007176	35	PAR	2001007183	42	PAR
2001007177	36	PAR	2001007184	43	PAR
2001007178	37	PAR	2001007185	44	PAR
2001007179	38	PAR	2001007186	45	PAR
2001007180	39	PAR			

MÁSCARA DESCART. PFF1-S SEM VALV. T-650-S

Código	Descrição	Und.
9139120005	sem válvula	UN

MÁSCARA DESCART. PFF2-V COM VALV. T-750-V

Código	Descrição	Und.
9139120110	com válvula	UN

MÁSCARA DESCART. PFF2-S SEM VALV. T-750-S

Código	Descrição	Und.
9139120053	sem válvula	UN

The image features a person's hands in a striped shirt using a tape dispenser to seal a cardboard box. The scene is overlaid with a teal gradient and a dark teal rectangular box containing the word 'ADESIVOS'. In the lower-left corner, a hand is shown applying adhesive from a dispenser onto a wooden surface. A large, dark teal, textured triangular shape is positioned on the right side of the image.

ADESIVOS

COLA PUR



Código	Descrição	Emb.
9164100045	Tekbond - bege 500ml	UN
2001004117	Jowapur 500g - cura lenta	UN
2001004015	Jowapur 500g - cura rápida	UN

ADESIVO DE POLIURETANO PU 40



Código	Descrição	Emb.
9164100037	Preto 359g	UN
9164100035	Cinza 365g	UN

SILICONE NEUTRO INCOLOR



Código	Descrição	Emb.
2604010805	Tekbond - 280g	UN
9164100026	Unipega - 400g	UN

PISTOLA PARA TUBO DE SILICONE



Código	Capacidade	Emb.
1114088625	280 ml	UN

KIT MOVELEIRO



Código	Descrição	Emb.
9164100047	Adesivo TB200g + ativador QFS200ml	UN

ADESIVO INSTANTÂNEO



Código	Descrição	Emb.
9162351401	20g - moveleiro	UN
9164100034	100g - moveleiro	UN
9164100014	20g - 793	UN
9164100015	100g - 793	UN

ADESIVO INSTANTÂNEO GEL



Código	Descrição	Emb.
1093011006	20g	UN
9164100046	100g	UN

ADESIVO MS HÍBRIDO A BASE D'ÁGUA



Código	Descrição	Emb.
9164100049	Tekbond - branco 400g	UN
9164100029	Unipega - branco 400g	UN

ADESIVO MONTA E FIXA



Código	Descrição	Emb.
1200008411	Henkel - 360g	UN
9164100016	Unipega - clear 24h 400g	UN

CASCOREZ COLA MADEIRA



Código	Descrição	Emb.
1093015728	250g	UN

MASSA PARA MADEIRA F - 12

Código	Cor	Quantidade	Emb.
8055525011	Branca	400g	UN
6617801696	Branca	1,65kg	UN
6617001750	Branca	6,5kg	UN
8055524626	Branca	16kg	UN
6617801825	Castanho	1,65kg	UN

Código	Cor	Quantidade	Emb.
8055524915	Cerejeira	1,65kg	UN
6617801542	Imbuia	1,65kg	UN
6617801511	Marfim	1,65kg	UN
6617801573	Mogno	1,65kg	UN

CASCOREZ EXTRA

Código	Descrição	Emb.
1093015995	500g	UN
1093016008	1kg	UN
1093043370	5kg	UN
1093043356	10kg	UN
1093043363	20kg	UN

CASCOREZ SECAGEM RÁPIDA

Código	Descrição	Emb.
1093044445	1kg	UN
1093044452	5kg	UN

FLEXITE ACÉTICO USO GERAL

Código	Descrição	Emb.
1093020579	50g incolor	UN
1200008308	252g incolor	UN
9164100025	400g incolor	UN
9164100019	400g branco	UN
9164100017	400g cinza	UN
9164100018	400g preto	UN

FLEXITE PLÁSTICOS, METAIS E PEDRAS

Código	Descrição	Emb.
1093039762	280g incolor	UN

COLA HOT MELT

Código	Descrição	Cor	Emb.
2001004109	Alta temp. 5kg	Branca	KG
2001004013	Alta temp. 5kg	Nat	KG
2001004108	Alta temp. 5kg	Nat	KG
9161725012	Alta temp. 20kg	Transp	KG
9260450204	Alta temp. 20kg	Branca	KG
2001004107	Baixa temp. 5kg	Branca	KG
2001004106	Baixa temp. 5kg	Nat	KG

COLA PVA

Código	Descrição	Emb.
9828001046	Tubo 1 kg	UN
9828001053	Balde 4 kg	UN
9828001060	Balde 10 kg	UN
9828001077	Barrica 25 kg	UN
9828001084	Barrica 50 kg	UN

APLICADOR DE FITA

Código	Descrição	Emb.
3946094348	50 mm - Manual	UN

ROLO DE FITA ISOLANTE

Código	Descrição	Emb.
7613361252	19x5mm	UN
7613361269	19x10mm	UN
7613000007	19x20mm	UN

ROLO DE FITA CREPE



Código	Descrição	Emb.	Código	Descrição	Emb.
6193242715	16x50mm	UN	6193000018	48x50mm	UN
6193200098	18x50mm	UN	9829001076	19x50m	UN
6193225817	25x50mm	UN	6193000001	38x50mm	UN
6193223196	32x50mm	UN			

ROLO DE FITA ADESIVA



Código	Descrição	Emb.	Código	Descrição	Emb.
2001000185	PP 32 - 48x50m transp.	UN	2001000779	PP 40 - 36x50m transp.	UN
9171002554	PP 32 - 48x100m transp.	UN	9107500002	PP 40 - 38x100m transp.	UN
2001001156	PP 33 - 48x100m marrom	UN	2001001056	PP 40 - 48x50m marrom	UN
8999000636	PP 33 - 48x100m Hot Melt transp.	UN	2001001057	PP 33 - 48mmx1.200m Hot Melt transp.	UN
9813020011	PP 40 - 48x100m transp.	UN			UN

ROLO FITA DUPLA FACE TRANSPARENTE 210 LVD



Código	Dimensões	Emb.
1641610007	9mmx1mmx20m	UN

FITA DUPLA FACE VHB



Código	Dimensões	Emb.
2001002803	12mmx40mm	UN
2001002802	12mmx50mm	UN
9829001038	15mmx20m	UN
2001000463	30mmx20m	UN
2001003928	100mmx20m	UN

BATENTE DE SILICONE BFK

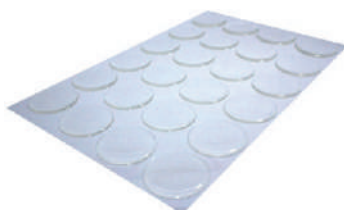

Código	Descrição	Emb.
9812080132	13mm	MIL
9812080125	15mm	MIL
9812080112	20mm	MIL

A person wearing a white long-sleeved shirt and work gloves is working with a wire fence. The person is holding a wire and appears to be securing it to a wooden post. The background shows a rural landscape with a wooden fence and tall grass. The entire image has a green tint and a dark green diagonal overlay on the right side.

AGROPECUÁRIOS

ESTICADOR GANCHO OLHAL LEVE SV GALVANIZADO



Código	Descrição	Emb.
9103000005	Ø1/2"	UN
9103000269	Ø1/4"	UN
9103000004	Ø3/8"	UN
9103000276	Ø5/16"	UN

CLIPS GRAMPO PARA CABO DE AÇO LEVE



Código	Descrição	Emb.
9103000115	1/2 NRO.12	UN
9103000085	1/4 NRO.6	UN
9103000061	1/8 NRO.3	UN
9103000108	3/8 NRO.10	UN
9103000078	3/16 NRO.5	UN
9103000092	5/16 NRO.8	UN

CABO DE AÇO GALVANIZADO



Código	Descrição	Emb.
9103000030	6x7 AF 1/4"	MT
9103000016	6x7 AF 1/8"	MT
9103000054	6x7 AF 3/8"	MT
9103000023	6x7 AF 3/16"	MT
9103000055	6x7 AF 5/16"	MT
9103000048	6x7 AA 5/64"	MT

GRAMPO GALVANIZADO



Código	Descrição	Emb.
1738018671	19x11-1x9 (20 kg)	KG

GRAMPO POLIDO



Código	Descrição	Emb.
1738018633	19x11-1x9 (20 kg)	KG

CORDALHAS CULTURAS AÉREAS GALVANIZADAS



Código	Descrição	Emb.
9173800455	4,87mm 500m	UN

ARAME CULTURAS AÉREAS



Código	Descrição	Emb.
9173800332	2,10mm 500m	UN
1738943041	2,10mm 1000m	UN

ARAME OVALADO



Código	Descrição	Emb.
9173800370	14x16 500m	UN
1738683442	14x16 1250m	UN

ARAME RECOZIDO



Código	Descrição	Emb.
1738038501	BWG18 - 1,25mm	UN
9173800042	BWG10 - 3,4mm	KG
9173800059	BWG12 - 2,77mm	KG
9173800097	BWG14 - 2mm	UN

Código	Descrição	Emb.
9173800066	BWG14 - 2mm	KG
9173800103	BWG16 - 1,65mm	UN
9173800073	BWG16 - 1,65mm	KG

ARAME FARPADO ELEFANTE

Código	Descrição	Emb.
1738651281	2,2mm 250m PL+FI	UN
1738651298	2,2mm 400m PL+FI	UN

ARAME FARPADO URSO

Código	Descrição	Emb.
9173800011	1,6mm 250m PL+FI	UN
1738647345	1,6mm 500m PL+FI	UN

ARAME GALVANIZADO



Código	Descrição	Emb.
1738342950	1,24mm BWG18	KG
9173800561	1,24mm BWG18	KG
1738342936	1,65mm BWG16	KG
9173800547	1,65mm BWG16	KG
1738342929	2,10mm BWG14	KG
9173800523	2,10mm BWG14	KG

Código	Descrição	Emb.
1738444227	2,76mm BWG12	KG
9173800509	2,76mm BWG12	KG
9173800493	3,4mm BWG10	KG
9173800486	4,19mm BWG8	KG
9173800479	5,15mm BWG6	KG

TELA ALAMBRADO

Código	Descrição	Emb.
9173800141	2,10mm 10x5cm 1,0x25m	UN
1738938870	2,10mm 10x5cm 1,2x25m	UN
1738938849	2,10mm 10x5cm 1,5x25m	UN
1738938924	2,10mm 10x5cm 1,8x25m	UN
1738938931	2,10mm 10x5cm 2,0x25m	UN

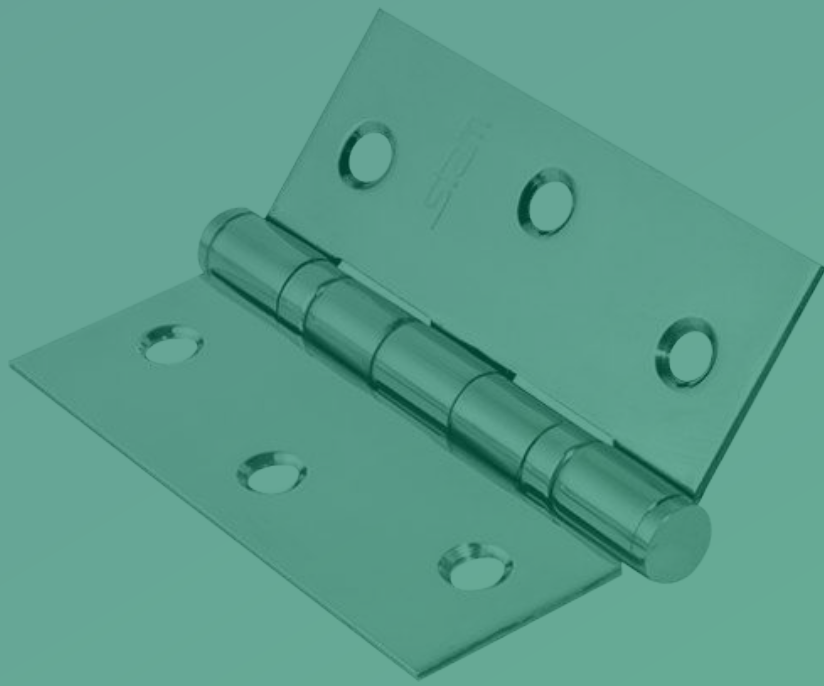
Código	Descrição	Emb.
9173800158	2,76mm 15x5cm 1x25m	UN
1738938627	2,76mm 15x5cm 1,2x25m	UN
1738938641	2,76mm 15x5cm 1,5x25m	UN
1738938702	2,76mm 15x5cm 1,8x25m	UN
1738938719	2,76mm 15x5cm 2x25m	UN



DOBRADIÇAS



DOBRADIÇA PINO BOLA



Código	Descrição	Acabamento	Emb.
9129100312	2.1/2 PB	Ouro Velho	UN
8437279853	3x2 1/2 PB	Ouro Velho	UN
8437279747	3x2 1/2 PB	Zincado Amarelo	UN
8437281696	3x2 1/2 PB	Cromado	UN
8437279730	3x2 1/2 PB	Zincado Branco	UN
8437000013	3x2 1/2 PB	Cromado	UN
8437281399	3x2 1/2 PB	Cromado Acetinado	UN
8437280576	3x2 1/2 PB	Latonado Oxidado	UN

Código	Descrição	Acabamento	Emb.
8437000018	3x2 1/2 PB	Cromado Acetinado	UN
8437270038	1,9mm 3x2.1/2 PB	Ouro Velho	UN
8437280453	3x2 PB	Ouro Velho	UN
8437280408	3x2 PB	Zincado Amarelo	UN
8437280446	3x2 PB	Zincado Branco	UN
8437280125	3x3 PB	Ouro Velho	UN
8437280040	3x3 PB	Zincado Amarelo	UN

DOBRADIÇA PORTA POPULAR PINO SIMPLES SOLTO



Código	Dimensões	Acabamento	Qnt. furos	Emb.
9126002103	1.1/2x1.3/8x1,2	Polido	2	UN
9126002172	1.1/2x1.3/8x1,2	Zincado Branco	2	UN
9126002110	2x1.1/2x1,2	Polido	2	UN
9126002189	2x1.1/2x1,2	Zincado Branco	2	UN
9126002128	2.1/2x1.5/8x1,2	Zincado Preto	3	UN
9126002127	2.1/2x1.5/8x1,2	Polido	3	UN
9126002196	2.1/2x1.5/8x1,2	Zincado Branco	3	UN

Código	Dimensões	Acabamento	Qnt. furos	Emb.
9126002204	3x1.7/8x1,2	Polido	3	UN
9126002134	3x1.7/8x1,5	Polido	3	UN
9126002202	3x1.7/8x1,5	Zincado Branco	3	UN
9126002141	3.1/2x2.3/16x1,5	Polido	3	UN
9126002240	3.1/2x2.3/16x1,5	Zincado branco	3	UN
9126002165	4x2.5/8x2	Polido	4	UN
9126002226	4x2.5/8x2	Zincado Branco	4	UN

DOBRADIÇA RETA PINO FIXO



Código	Dimensões	Acabamento	Emb.
9104000046	1.1/2x1.1/16x0,8	Zincado Amarelo	UN
9104000152	1.1/2x1.1/16x0,8	Zincado Branco	UN
9104000015	1.1/4x1x0,8	Zincado Amarelo	UN
9104000022	1x3/4x0,6	Zincado Amarelo	UN

Código	Dimensões	Acabamento	Emb.
9104000053	2x1.7/16x0,9	Zincado Amarelo	UN
9104000054	2x1.7/16x0,9	Zincado Branco	UN
9104000060	2.1/2x1.3/16x0,9	Zincado Amarelo	UN
8422182243	3/4x1.37/64x0,4	Zincado Amarelo	UN

DOBRADIÇA 184 LEVE PINO SIMPLES SOLTO



Código	Dimensões	Acabamento	Emb.
9129000199	1.1/2x1.3/8x1,3	Zincado Branco	UN
9129000205	2x1.1/2x1,3	ZB Pino Latonado	UN
9129000212	2.1/2x1.5/8x1,3	ZB Pino Latonado	UN
9129000137	2.1/2x1.5/8x1,3	Ferro Polido	UN
9129000120	2x1.1/2x1,30	Ferro Polido	UN
9129000274	3x1.7/8x1,4	Ouro Velho	UN

Código	Dimensões	Acabamento	Emb.
9129000229	3x1.7/8x1,4	ZB Pino Latonado	UN
9129000151	3.1/2x2.1/4x1,6	Ferro Polido	UN
9129000236	3.1/2x2.1/4x1,6	ZB Pino Latonado	UN
9129000168	3x2.1/2x1,9	Ferro Polido	UN
9129000243	3x2.1/2x1,9	ZB Pino Latonado	UN
9129000267	4x2.5/8x1,70	ZB Pino Latonado	UN

DOBRADIÇA DOBRADA



9104000000



9105000021



9105000038

Código	Descrição	Acabamento	Emb.
9105000021	2.1/2x1x1,2mm c/ regulagem - 304	Zincado Amarelo	UN
9104000000	50mmx22mmx0,80mmx3,5mm c/ regulagem - 304	Zincado Amarelo	UN
9105000038	62mm s/ regulagem - 405	Zincado Amarelo	UN

DOBRADIÇA 101 LEVE PINO SIMPLES SOLTO

Código	Dimensões	Acabamento	Emb.
9129000145	3x1.7/8x1	ZB Pino Latonado	UN

DOBRADIÇA ABA EMBUTIDA INOX

Código	Descrição	Emb.
2001000737	306 4x3 c/ rolamento	UN

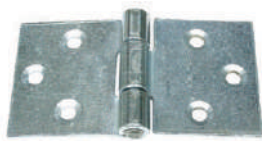
DOBRADIÇA QUADRADA

Código	Descrição	Emb.
3853233106	1,0	UN
3853233120	1,25	UN
3853233151	1,50	UN
3853233175	1,75	UN
3853233205	2,0	UN

DOBRADIÇA VAI VEM

Código	Dimensões	Acabamento	Emb.
3853232208	3"	Cromado	UN
3853232406	3"	ZB	UN
3853232307	3"	Preto	UN
3853232154	4"	ZB	UN
3853232352	4"	Preto	UN
3853232253	4"	Cromado	UN

DOBRADIÇA PIVOTANTE



Código	Descrição	Marca	Emb.
2327402970	Inox polido 80kg	Soprano	UN
8437272731	Inox 80kg	Celsus	UN

DOBRADIÇA CILÍNDRICA

Código	Dimensões	Acabamento	Emb.
9232750493	3/8	Ferro Tamborado	UN
9232750127	5/8	Ferro Tamborado	UN

DOBRADIÇA BORBOLETA PARA JANELA

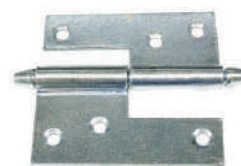
Código	Emb.
3853200726	UN

DOBRADIÇA HAMBURGUESA

Código	Descrição	Emb.
3853238804	8cm	UN

DOBRADIÇA PARA PORTÃO PARAFUSAR

Código	Descrição	Emb.
3853240067	Ø6	UN

DOBRADIÇA PARA PORTÃO DUAS HASTES - PARAFUSAR

Código	Descrição	Emb.
3853247042	4cm	UN
3853247066	6cm	UN
3853247080	8cm	UN

DOBRADIÇA PARA PORTÃO CHAPA

Código	Descrição	Emb.
3853200351	1,90mm	UN



DOBRADIÇA PARA PORTÃO CHAPA REFORÇADA

Código	Descrição	Emb.
3853200368	3,35mm	UN



DOBRADIÇA DE LEME

Código	Descrição	Emb.
3853234042	Ø4	UN
3853234066	Ø6	UN
3853234080	Ø8	UN



DOBRADIÇA PARA VENEZIANA

Código	Descrição	Emb.
3853224562	6cm	UN

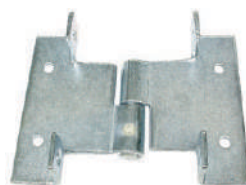



FECHADURAS

FECHADURA ÍCARO ROSETA QUADRADA OU REDONDA



*Roseta Quadrada



Roseta redonda

Código	Versão	Acabamento	Emb.
2327051611	Banheiro	Cromada	UN
2327051581	Banheiro	Ant.brass	UN
2327051598	Externa	Cromada	UN
2327051574	Interna	Ant.brass	UN
2327051995	Interna	Cromada	UN

Roseta Quadrada

Código	Versão	Acabamento	Emb.
9232751957	Banheiro	Cromada	UN
2327053295	Externa	Cromada	UN
9232750097	Interna	Cromada	UN

Roseta Redonda

FECHADURA ÍCARO ESPELHO OVAL



Código	Versão	Acabamento	Emb.
2327051529	Banheiro	Ant.brass	UN
2327051550	Banheiro	Cromada	UN
2327051505	Externa	Ant.brass	UN
2327051536	Externa	Cromada	UN
2327051512	Interna	Ant.brass	UN
2327051543	Interna	Cromada	UN

FECHADURA BORA



Código	Versão	Acabamento	Emb.
2327046358	Banheiro	Antique Brass	UN
2327046334	Externa	Antique Brass	UN
2327046341	Interna	Antique Brass	UN

FECHADURA POPLINE PY E10



Código	Versão	Acabamento	Emb.
2327054797	Banheiro	Inox	UN
2327054780	Interna	Inox	UN
2327010366	Externa	Cromada	UN

FECHADURA POPLINE ESTREITA



Código	Versão	Acabamento	Emb.
2327008820	Externa	Inox	UN
2327009285	Externa	Inox	UN

FECHADURA POPLINE PY E11



Código	Versão	Acabamento	Emb.
2327011820	Banheiro	Inox	UN
2327010342	Externa	Cromada	UN
2327011769	Interna	Inox	UN

FECHADURA PALI



Código	Versão	Acabamento	Emb.
2327046075	Banheiro	Ant.brass	UN
2327046051	Externa	Ant.brass	UN
2327046068	Interna	Ant.brass	UN
2327046129	Interna	Cromada	UN

FECHADURA PALI ROSETA



Código	Versão	Acabamento	Emb.
2327050201	Externa	Cromado	UN
2327049700	Banheiro	Cromado	UN
2327050102	Interna	Cromado	UN

FECHADURA IPANEMA



Código	Versão	Acabamento	Emb.
2327012186	Interna	Metalix Preto	UN

FECHADURA



Código	Versão	Acabamento	Emb.
3858350129	803/03 - Externa	Inox	UN
3858350273	803/03 - Externa	Oxidado	UN
3858328159	813/03 - Interna	Oxidado	UN

FECHADURA



Código	Versão	Acabamento	Emb.
3858332422	804/11 - Externa	Inox	UN
3858332446	804/11 - Externa	Oxidado	UN
3858332569	814/11 - Interna	Oxidado	UN

FECHADURA



Código	Versão	Acabamento	Emb.
3858332415	804/11 - Externa	Escovado	UN
3858332422	804/11 - Externa	Inox	UN
3858332415	804/11 - Externa	Escovado	UN
3858332446	804/11 - Externa	Oxidado	UN
3858332538	814/11 - Interna	Escovado	UN
3858332569	814/11 - Interna	Oxidado	UN
3858332651	824/11 - Banheiro	Escovado	UN

FECHADURA



Código	Versão	Acabamento	Emb.
3858332804	814/10 - Interna	Oxidado	UN

FECHADURA



Código	Versão	Acabamento	Emb.
3858113328	1810/21 - Interna	Inox	UN
3858113502	1820/21 - Banheiro	Inox	UN

FECHADURA 601/602/603



Código	Versão	Acabamento	Emb.
3858000073	Externa Estreita	Branco	UN
3858350082	Externa Estreita	Inox	UN

FECHADURA VENEZA



Código	Versão	Acabamento	Emb.
2327000029	Externa - 40x53	Latonado Oxidado	UN

FECHADURA 1501/06



Código	Versão	Acabamento	Emb.
3858338639	1501/06 - Externa	Colonial	UN

FECHADURA CILÍNDRICA TULIPA



Código	Descrição	Emb.
2327038674	90 mm - cromada	UN

MAÇANETA RETA SAGAZ



Código	Acabamento	Emb.
2327042275	Cromado	UN

BICO DE PAPAGAIO 27MM



Código	Versão	Acabamento	Emb.
2327041605	Externa	Cromado	UN

BICO DE PAPAGAIO 29MM



Código	Versão	Acabamento	Emb.
2327010120	Externa	Cromado	UN

BICO DE PAPAGAIO 45MM



Código	Versão	Acabamento	Emb.
2327049311	Externa	Antique Brass	UN
2327047850	Externa	Cromado	UN
2327047898	Interna	Antique Brass	UN
2327047874	Interna	Cromado	UN

FECHADURA AUXILIAR



Código	Acabamento	Emb.
2327010038	Cromada	UN

FECHADURA AUXILIAR CLASSIC 1006



Código	Versão	Acabamento	Emb.
3858000056	Roseta quadrada	Cromado	UN
3858000057	Roseta redonda	Cromado	UN

FECHADURA AUXILIAR CLASSIC 1007



Código	Versão	Acabamento	Emb.
3858000058	Roseta quadrada	Cromado	UN

FECH. C/ TRAVA LATERAL COMPLETA ESCAMOTEÁVEL



Código	Acabamento	Emb.
2327411392	Ferro Cromado	UN

* Para 3 gavetas

FECHADURA 108 COM BARRA 1M



Código	Versão	Acabamento	Emb.
2327411668	S/ guia e s/ peg. escamot	Cromado	UN

FECHADURA DE SOBREPOR 861



Código	Descrição	Acabamento	Emb.
2327400570	Cilindro 22mm capa plástica	Niquelado	UN
2327400631	Cilindro 31mm capa plástica	Niquelado	UN

FECHADURA UNIV. P/ MÓVEIS DE AÇO 2 CHANFROS



Código	Acabamento	Emb.
9232730716	Cromado	UN

FECHADURA PARA MÓVEIS DE AÇO GIRO 180°

Código	Acabamento	Emb.
9232730303	Cromado	UN

*Lingueta não acompanha o produto

CILÍNDRIO ZAMAC CROMADO SOPRANO

Código	Descrição	Emb.
2327037660	53mm	UN

FECHADURA PARA GAVETAS

Código	Versão	Acabamento	Emb.
3858121248	301 gaveta curta	Niquelado	UN
3858000063	301 mesmo segredo	Niquelado	UN
3858121262	302 gaveta longa	Niquelado	UN
3858000033	302 mesmo segredo	Niquelado	UN

CILÍNDRIO

Código	Versão	Acabamento	Emb.
3858000032	803/804/1801	Cromado	UN

FECHADURA METÁLICA

Código	Acabamento	Emb.
2327400850	Zincado Branco	UN

FECHADURA 1005 PIVOTANTE

Código	Versão	Acabamento	Emb.
3858000022	Roseta quadrada	Cromado	UN

FECHO PIVOTANTE AUXILIAR

Código	Acabamento	Emb.
3858000071	Cromado	UN

BATENTE L PARA FECHADURA

Código	Acabamento	Emb.
2327000034	Zincado Branco	UN

TRAVA DE SEGURANÇA 1004

Código	Versão	Acabamento	Emb.
3858109772	Externa Tetra	Inox	UN
3858109857	Externa Tetra	Inox	UN

ENTRADA DE CHAVE

Código	Acabamento	Emb.
2327413136	Niquel fosco	UN



FECHO LIVRE/OCUPADO

Código	Acabamento	Emb.
2327045849	Cromado	UN



FECHO ALAVANCA

Código	Descrição	Acab.	Emb.
9110000368	FEC 301	Fosco	UN
9110000375	FEC 302	Bronze	UN
9110000382	FEC 303	Preto	UN



FECHO GATILHO POLIAMIDA

Código	Descrição	Acabamento	Emb.
9110000351	FEC 300	Preto	UN



FECHO PRESSÃO

Código	Acabamento	Emb.
2327401508	Niquelado	UN



FECHO ROLETE DUPLO / SIMPLES

Código	Acabamento	Emb.
2327401515	Zincado Branco	UN
7584700012	Niquelado	UN
7584700654	Preto	UN
9106001003	Zincado Amarelo	UN
*2327403953	Zincado Branco	UN



*Fecho simples

FECHO PARA PORTÃO

Código	Emb.
3853200184	UN



FECHO PAPAGAIO PARA PORTÃO

Código	Acabamento	Emb.
9232750172	Ferro Tamborado	UN



FECHO PINO

Código	Acabamento	Emb.
8437292265	Ouro Velho	UN



FECHO PINO PRESSÃO

Código	Descrição	Emb.
843700004	Ouro Velho	UN



FECHO CONCHA

Código	Acabamento	Emb.
8437286929	Ouro Velho	UN



CONCHA

Código	Descrição	Descrição	Emb.
8437279600	45x96 2631	Cromado	UN
8437279433	45x96 2637	Zinco Branco	UN
8437279204	45x96 2692	Ouro Velho	UN

CREMONA ESTAMPADA MINI COM 4 PASSADORES

Código	Acabamento	Emb.
2327020716	Zincado Branco	UN

CREMONA

Código	Descrição	Acabamento	Emb.
8437288473	Chapa 2265	Zincado Amarelo	UN
8437288527	Chapa 2267	Zincado Branco	UN
8437288411	Chapa 2271	Ouro Velho	UN
8437283843	Embutir 2869	Ouro Velho	UN
8437284246	Sobrepor 1997	Cromado	UN
8437284130	Sobrepor 2012	Ouro Velho	UN

CREMONA RETANGULAR ESTAMP. COM 4 PASSADORES

Código	Descrição	Emb.
2327020730	Cromado	UN
2327020761	Zincado Branco	UN

VARA PARA CREMONA (VARETA)

Código	Marca	Descrição	Acabamento	Emb.
9232753005	Soprano	Oca 1.2m	Zincado Branco	UN
9232752893	Soprano	Maciça 1.2m	Zincado Branco	UN
8437286394	Celsus	Maciça 1.2m	Lat. Oxidado	UN
8437286134	Celsus	4x2,70x1200mm	Preto	UN

FECHO PARA PORTÃO

Código	Descrição	Acabamento	Emb.
2327022581	95mm	Zincado Amarelo	UN
2327022574	122mm	Zincado Amarelo	UN

FERROLHO CHATO

Código	Descrição	Emb.
3853202409	4"	UN
3853202508	5"	UN

FERROLHO CHATO TIPO LEVE

Código	Acabamento	Emb.
3853204250	2,5"	UN
3853204304	3"	UN
3853204359	3,5"	UN
3853204403	4"	UN

FERROLHO UNHA

Código	Descrição	Acabamento	Emb.
3853203161	16cm	Zincado Branco	UN

FERROLHO FIO REDONDO

Código	Descrição	Emb.
3853205400	4"	UN
3853205509	5"	UN
3853205608	6"	UN



FERROLHO FIO REDONDO TIPO LEVE

Código	Descrição	Emb.
3853209255	2,5"	UN
3853209309	3"	UN
3853209408	4"	UN
3853209507	5"	UN



FERROLHO PORTA CADEADO

Código	Descrição	Emb.
3853206407	4"	UN
3853206506	5"	UN
3853206650	6"	UN



FERROLHO PORTA CADEADO REAL

Código	Descrição	Emb.
3853256211	2"	UN
3853256310	3"	UN
3853256419	4"	UN



TARJETAS

Código	Descrição	Emb.
3853216154	1,5"	UN
3853216208	2"	UN
3853216253	2,5"	UN
3853216307	3"	UN

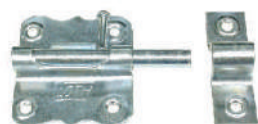

TARJETA METALIX 2.1/2

Código	Acabamento	Emb.
9232750936	Metalix Preto	UN



TRINCO PORTINHOLA BATENTE ALTO

Código	Acabamento	Emb.
9232750974	Oxidado Envernizado	UN



TRINCO PORTINHOLA BATENTE BAIXO

Código	Acabamento	Emb.
9232750424	Niquelado	UN



PORTA CADEADO

Código	Descrição	Emb.
3853221257	2,5"	UN
3853221301	3"	UN
3853221356	3,5"	UN
3853221400	4"	UN
3853221509	5"	UN
3853221608	6"	UN



PORTA CADEADO PARA MALA

Código	Emb.
3853200238	UN



CADEADO

Código	Modelo	Marca	Emb.
385800079	20mm	Stam	UN
3858001014	25mm	Stam	UN
3858002066	30mm	Stam	UN
3858003018	35mm	Stam	UN
3858004053	45mm	Stam	UN

PINO PARA TRAVAMENTO

Código	Descrição	Acabamento	Emb.
2327407111	PEG 19mm	Zamac Tamborado	UN
2327407098	PEG 7mm	Zamac Tamborado	UN

TRAVA PORTA DE PISO

Código	Acabamento	Emb.
9232750349	Cromado	UN
9232750356	Latonado Oxidado	UN

TRAVA PORTA DE PAREDE

Código	Acabamento	Emb.
9232750790	Cromado	UN

FIXADOR MAGNÉTICO DE PORTA (TRAVA PORTA)

Código	Emb.
1065999308	UN

PRENDEDOR PARA VENEZIANA - PARAFUSAR

Código	Descrição	Emb.
3853204540	4cm	UN

PRENDEDOR DE ARMÁRIO

Código	Descrição	Emb.
3853203826	382	UN
3853203833	383	UN
3853203840	384	UN
3853203857	385	UN

LIMITADOR

Código	Descrição	Emb.
8437278870	22x35 FZ 3208	UN
8437278948	22x40 FZ 3220	UN

GUIA DE BARRA BAIXO

Código	Descrição	Emb.
2327404752	PEAD Preto-63	UN

VISOR DE PORTAS

Código	Acabamento	Emb.
2327067346	Antique Brass	UN
2327000503	Cromado	UN

CASTANHA INJETADA

Código	Descrição	Emb.
8437284352	Ouro Velho 3425	UN



CASTANHA ESTAMPADA

Código	Descrição	Emb.
8437284369	Ouro Velho 3409	UN
8437284383	Zincada Branca 3405	UN



CONJUNTO BRAÇO MAXIMAR



Código	Descrição	Tamanho	Acabamento	Emb.
911000009	BRA 0400	270mm	Fosco	UN
9110000207	BRA 699	320mm	Preto	UN
9110000030	BRA 4000	320mm	Fosco	UN
9110000047	BRA 4001	320mm	Bronze	UN
9110000184	BRA 699	320mm	Fosco	UN
9110000214	BRA 7000	400mm	Fosco	UN
9110000061	BRA 0403	420mm	Fosco	UN
9110000078	BRA 0405	420mm	Bronze	UN
9110000085	BRA 0405	420mm	Preto	UN
9110000092	BRA 0408	620mm	Fosco	UN
9110000108	BRA 0407	620mm	Bronze	UN
9110000115	BRA 0408	620mm	Preto	UN

A person is using a screwdriver on a wooden surface. In the background, a ruler and a level are visible. The image is overlaid with a dark teal gradient and a green border around the text.

FERRAMENTAS

ESTILETE PLÁSTICO 18MM

Código	Descrição	Emb.
9138057108	Plástico plus	UN
9138056805	Reforçado largo	UN



ESTILETE LARGO COM TRAVA RETRÁTIL 6"

Código	Emb.
9811140707	UN



LÂMINA DE ESTILETE LARGA 18MM

Código	Descrição	Emb.
9138056705	Conjunto com 10 unidades	UN
1114051803	Conjunto com 10 unidades	UN



ESCALA MÉTRICA MADEIRA 2M

Código	Dobras	Emb.
3820002010	10	UN



TRENA

Código	Descrição	Dimensões	Emb.
7095037130	Irwin Standard	5m	UN
7095037123	Irwin Standard	3m	UN



ESQUADRO

Código	Descrição	Emb.
1114013399	30cm	UN



ALICATE UNIVERSAL

Código	Descrição	Emb.
1114008869	8"	UN



MARTELO DE UNHA

Código	Descrição	Emb.
9811140790	25mm	UN



ARCO DE SERRA FIXO

Código	Descrição	Emb.
1114001266	12"	UN



SERRA TICO TICO PARA MADEIRA

Código	Descrição	Emb.
7095036072	8 dentes	UN
7095036105	10 dentes	UN
7095036181	12 dentes	UN
7095036112	20 dentes	UN



SERRA MANUAL BIMETÁLICA

Código	Descrição	Emb.
2472201178	24 dentes	UN

FORMÃO CHANFRADO

Código	Dimensões	Emb.
1114010268	1"	UN
1114010282	3/4"	UN

LIMA ENXADA 8"

Código	Descrição	Emb.
9154350023	Com cabo	UN
9154350024	Sem cabo	UN

LIMA PARA MOTOSERRA

Código	Descrição	Emb.
9154350016	8x7/32 - sem cabo	UN

CHAVE DE FENDA TOCO PONTA CRUZADA

Código	Descrição	Emb.
1114013795	1/4x1.1/2	UN
1114013788	3/16x1.1/2	UN

CHAVE TESTE PONTA CHATA

Código	Descrição	Emb.
1114005806	1/8x3	UN

PONTEIRA PHILLIPS 1/4

Código	Descrição	Emb.
9183001050	2x25	UN
9183001019	2x25	UN
9183001051	2x50	UN
9183001033	2x50	UN
9183001040	2x70	UN

PONTA INSERT BIT PHILLIPS

Código	Descrição	Emb.
7095031384	25mmx1/4x1	UN
7095031391	25.4mmx1/4x2	UN

PONTA POWER BIT PHILLIPS

Código	Descrição	Emb.
7095031490	49.2mmx1/4x2	UN
7095031520	70.0mmx1/4x2	UN
7095031582	101.6mmx1/4x2	UN

R100 REBITADOR MANUAL IRWIN

Código	Emb.
7095886980	UN

BROCA PARA CONCRETO



Código	Dimensões	Descrição	Emb.
8610035108	5mm	Para concreto	UN
8610035109	6mm	Para concreto	UN
8610035110	8mm	Para concreto	UN
7095014097	75mmx04.00mm	Ponta MD	UN
7095014103	90mmx05.00mm	Ponta MD	UN
7095014127	100mmx06.00mm	Ponta MD	UN
7095014141	100mmx07.00mm	Ponta MD	UN

Código	Dimensões	Descrição	Emb.
7095014158	120mmx08.00mm	Ponta MD	UN
7095014189	150mmx10.00mm	Ponta MD	UN
7095032879	160x8.00mm	MD SDS	UN
7095032794	110x6mm	SDS Plus	UN
7095040188	160x6.00mm	SDS Plus	UN
8605006100	6,00x100mm	Standard	UN

BROCA AÇO RÁPIDO HELICOIDAL DIN 338 PARA METAL



Código	Descrição	Emb.
7095000533	45mmx01.50mm	UN
7095000595	49mmx02.00mm	UN
7095000656	57mmx02.50mm	UN
7095000717	61mmx03.00mm	UN
7095000779	70mmx03.50mm	UN
7095000830	75mmx04.00mm	UN
7095000892	80mmx04.50mm	UN

Código	Descrição	Emb.
7095000953	86mmx05.00mm	UN
7095001011	93mmx05.50mm	UN
7095001073	93mmx06.00mm	UN
7095001134	101mmx6.50mm	UN
7095001301	117mmx8.00mm	UN
7095001523	133mmx10.00mm	UN

BROCA AÇO RÁPIDO HELICOIDAL DIN 338 ESQUERDA



Código	Descrição	Emb.
1297111882	3,0x61mm	UN
1297111998	4,0x75 mm	UN
1297112018	4,5x80mm	UN

Código	Descrição	Emb.
1297112049	5,5x93mm	UN
1297112056	6x93mm	UN
1297112032	5,0x86mm	UN

BROCA AÇO RÁPIDO



Código	Descrição	Marca	Emb.
8610020049	2,0x49mm	Dormer	UN
8610025057	2,5x57mm	Dormer	UN
8610030061	3,0x61mm	Dormer	UN
8610035070	3,5x70mm	Dormer	UN
8610040075	4,0x75mm	Dormer	UN
8610045080	4,5x80mm	Dormer	UN
8610035103	2mm	Tramontina	UN
8610035104	2,50mm	Tramontina	UN

Código	Descrição	Marca	Emb.
8610035105	3mm	Tramontina	UN
8610035106	3,50mm	Tramontina	UN
8610035107	4mm	Tramontina	UN
8610035092	4,5mm	Tramontina	UN
8610035093	5mm	Tramontina	UN
8610035095	6mm	Tramontina	UN
8610035097	7mm	Tramontina	UN
8610035098	8mm	Tramontina	UN



FERRAGENS EM GERAL

LÂMPADA DE EMBUTIR 12 LEDS



Código	Descrição	Emb.
2001002729	Espelho Branco / LED Branco	UN
2001002732	Espelho Cromado / LED Branco	UN

LÂMPADA DE EMBUTIR LED 4.4 W



Código	Descrição	Emb.
2001003521	Esp. branco 6000k branca fria	UN
2001002736	Esp. cromado 6000k branca fria	UN

LÂMPADA DE EMBUTIR 35MM



Código	Descrição	Emb.
8292020073	1,8w esp. aço esc. 6000k branca fria	UN
8292020075	1,8w esp. branco 6000k branca fria	UN
8292020074	1,8w esp. cromado 6000k branca fria	UN

DICROLED MÓVEIS 2W CARCAÇA PLÁSTICA



Código	Descrição	Emb.
2001002734	3000k LED Amarelo	UN
2001002733	6000k LED Branco	UN

LUMINÁRIA EMBUTIR POINT CIRCULAR 35MM 1,5W



Código	Descrição	Emb.
8999001245	Alumínio 6000k luz fria	UN
8999001246	Branco 6000k luz fria	UN
8999001247	Cromado 6000k luz fria	UN

LUMINARIA EMBUTIR POINT QUADRADA 35MM 1,5W



Código	Descrição	Emb.
8999001248	Alumínio 6000k luz fria	UN
8999001249	Branco 6000k luz fria	UN
8999001250	Cromado 6000k luz fria	UN

INTERRUPTOR REDONDO DE EMBUTIR



Código	Descrição	Emb.
8999000183	Branco simples 2 fios 15cm	UN
8999000186	Cinza simples 2 fios 15cm	UN
8999000185	Marrom simples 2 fios 15cm	UN
8999000184	Preto simples 2 fios 15cm	UN
8999000187	Branco paralelo 3 fios 10cm	UN
8999000188	Preto paralelo 3 fios 15cm	UN

CORRENTE VITÓRIA SEM FIM ZINCADA

Código	Descrição	Emb.
9134000122	N°5 Elo 1,8x9x33	MT
9134000108	N°7 Elo 1,2x6,5x23	MT

CORRENTE SOLDADA ELO ZINCADA

Código	Tipo	Diâmetro	Dimensões	Emb.
9134000306	Elo curto	2,0mm 5/64"	9x16	KG
9134000375	Elo curto	5,0mm 3/16"	18x33	KG
9134000788	Elo longo	5,0mm 3/16"	21x45	KG

ELETRODO

Código	Descrição	CX
9567801099	Eletrodo Esab Serral. Ø2,50	5KG
9567801105	Eletrodo Esab Serral. Ø3,25	5KG
9567801006	Eletrodo Conarco Ø2,50	5KG
9567801013	Eletrodo Conarco Ø3,25	5KG

ARAME SOLDA MIG

Código	Descrição	Emb.
1738345722	0,8mm c/ capa - ESAB	KG
1738340997	1mm c/ capa - ESAB	KG
1738644764	0,80mm - Gerdau	KG
9173800639	0,80mm c/ capa - Gerdau	KG
1738644801	1mm c/ capa - Gerdau	KG
9173800653	1mm - Gerdau	KG

ABRAÇADEIRA ROSCA SEM FIM

Código	Descrição	Emb.
3708023012	1/2x3/4	UN
3708023265	5/8x1.1/16	UN
3708023357	5/16x1/2	UN
3708022879	7/16x5/8	UN
3708023135	9/16x7/8	UN

ABRAÇADEIRA DE NYLON

Código	Descrição	Cor	Emb.
3946057114	100x2,5mm	Branca	UN
3946057091	150x3,5mm	Branca	UN
3946057053	200x3,5mm	Branca	UN
3946057039	300x4,5mm	Branca	UN

Código	Descrição	Cor	Emb.
3946057040	100x2,5mm	Preta	UN
3946057041	150x3,5mm	Preta	UN
3946057042	200x3,5mm	Preta	UN
3946057043	300x4,5mm	Preta	UN

GANCHO DE FERRO COM ROSCA PARA MADEIRA

Código	Especificação	Dimensões	Emb.
9134050028	15x30	1,9x25mm	CT

GANCHO COM ROSCA PARA BUCHA

Código	Especificação	Dimensões	Emb.
9134050127	B6	3,3x53mm	CT
9134050134	B8	4,4x67mm	CT



PITÕES DE FERRO COM ROSCA PARA MADEIRA

Código	Especificação	Dimensões	Emb.
9134050202	15x30	1,9x18mm	CT
9134050219	16x30	1,9x21mm	CT



PITÕES COM ROSCA PARA BUCHA

Código	Especificação	Dimensões	Emb.
9134050271	B5	2,9x42mm	CT
9134050288	B6	3,3x53mm	CT



RODÍZIO LEVE/MESA SGPL 4118

Código	Descrição	Emb.
1249017782	Giratório	UN



RODÍZIO 210

Código	Descrição	Dimensões	Emb.
9113020202	SGPL 210	2"x3/4"	UN
*9113020301	SGPLF 210	2"x3/4"	UN



* Com freio

RODÍZIO 312

Código	Descrição	Dimensões	Emb.
9113020509	SGPL 312	3"x1.1/4"	UN
*9113020608	SGPLF 312	3"x1.1/4"	UN



* Com freio

RODÍZIO 412

Código	Descrição	Dimensões	Emb.
9113020707	SFPL 412	4"x1.1/4"	UN
9113020806	SGPL 412	4"x1.1/4"	UN



* Com freio

RODÍZIO 512

Código	Descrição	Dimensões	Emb.
9113021100	SGPL 512	5"x1.1/4"	



RODÍZIO 75MM (NÍQUEL)

Código	Descrição	Emb.
2327000306	Com trava	UN
2327000307	Sem trava	UN



SISTEMA PARA PORTA DE PASSAGEM BT 07

Código	Descrição	Emb.
9101000353	Sistema para 01 porta	UN



ROLDANA RS 42

Código	Descrição	Emb.
8437272069	Roldana RS 42 ENPC 3653	UN
8437270016	Roldana RS 42 APC 608 CH. FZ	UN
8437270044	Roldana c/ rolamento APC 6000 CH. FZ	UN



ROLDANA RS 42 EN/A COM CHAPA E PORCA

Código	Descrição	Emb.
8437271697	Roldana 42 EN	UN
8437272342	Roldana 42A rol.608	UN

ROLDANA RS 42 ENF/AF COM CHAPA E PORCA



Código	Descrição	Emb.
8437271871	roldana 42 ENF 115/3637	UN
8437273356	roldana 42 AF rol.608	UN

ROLDANA RS 43 NPC

Código	Descrição	Emb.
8437272762	Roldana 43 NPC NY	UN

ROLDANA RS 43N COM CHAPA E PORCA

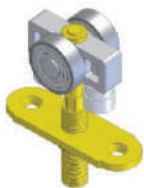

Código	Descrição	Emb.
8437372714	Roldana 43 N 4105	UN

ROLDANA RS 45 EN COM CHAPA E PORCA

Código	Descrição	Emb.
8437273240	Roldana 45EN c/ chapa e porca	UN

ROLDANA RS 45 EF

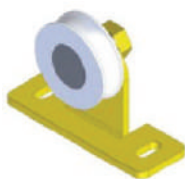
Código	Descrição	Emb.
8437273066	Roldana 45 EF PC NM chapa DF7	UN

ROLDANA RCHE 625N AF.5

Código	Descrição	Emb.
8437276296	Roldana 625N AF.5 CH central	UN

ROLDANA RCHE 11

Código	Descrição	Emb.
8437275299	Roldana 11 REG.	UN

ROLDANA RPH 11

Código	Descrição	Emb.
8437276432	Roldana s/ chapa e s/ porca girat.	UN

ROLDANA RPH 6000N/6 AF.5

Código	Descrição	Emb.
8437276562	Roldana 6000N/6 AF.5 s/ chapa e s/ porca	UN

ROLDANA RASE



Código	Descrição	Emb.
8437274551	11	UN
8437274605	12	UN
8437274612	19	UN
8437274636	20	UN
8437274650	23	UN
8437274674	24 H.105 AF.10 R.25 CR	UN
8437274797	6000N/6 AF.5 H.80	UN

GUIA D



Código	Descrição	Emb.
8437278023	11BN H. média	UN

GUIA E

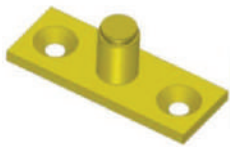

Código	Descrição	Emb.
8437277309	9 BN 15x40	UN
8437277194	9,5 BL 15x40	UN
8437277200	11 BN 20x60	UN

GUIA F

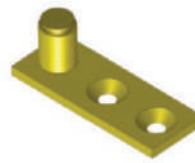

Código	Descrição	Emb.
8437277385	8 BL 15x40	UN
8437277699	9 BN 15x40	UN
8437277682	9,5 BL 20x60	UN
8437277422	9,5 BL 15x40	UN
8437277590	11 BL 20x60	UN
8437277446	11 BN 20x60	UN

SUPORE CABIDEIRO REDONDO



Código	Acabamento	Emb.
9168010111	Cromado	UN

SUPORE PRATELEIRA REGULÁVEL



Código	Descrição	Emb.
2327409443	Grande cromado	UN
2327408880	Pequeno cromado	UN

CABIDE SIMPLES



Código	Descrição	Acabamento	Emb.
1249010119	Gancho médio	Cromado	UN

SUPORE CABIDEIRO OBLONGO CENTRAL



Código	Acabamento	Emb.
9168010135	Cromado	UN

TUBO DE AÇO CROMADO



Código	Descrição	Dimensões	Emb.
0907266400	Redondo	25x3000mm esp. 0,75mm	UN
0960201400	Oblongo	15x30mm esp. 0,50mm	UN

ESQUADRO PARA ESQUADRIAS

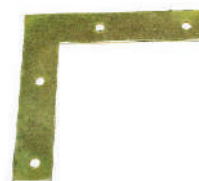

Código	Descrição	Emb.
3853234417	10cm	UN
3853234455	15cm	UN

PAPEL ONDULADO

Código	Descrição	Emb.
9999000003	400mm	KG
9999000001	1200mm	KG

ROLETE DE NYLON

Código	Descrição	Emb.
8437287780	11x12mm 1207	UN
8437287988	9x12mm 1205	UN

PUXADOR CLASSIC



Código	Descrição	Emb.
9232751124	Antique brass	UN
9232751100	Cromado	UN

PUXADOR METÁLICO DE PORTA EM U

Código	Descrição	Emb.
2327022345	Cromado	UN

PUXADOR AUSTER

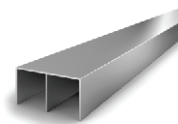
Código	Acabamento	Emb.
9232752985	Antique brass	UN
9232752978	Cromado	UN

PERFIL TRILHO ALUMÍNIO SUPERIOR

Código	Acabamento	Descrição	Emb.
6021324	Anod fosco	6000mm - DES 390	UN
6003001930	Anod	6120mm - DES 1004	UN

PERFIL TRILHO ALUMÍNIO INFERIOR

Código	Acabamento	Descrição	Emb.
6021325	Anod fosco	6000mm - DES 113	UN
6003001910	Anod fosco	6000mm - DES 309	UN
6003001900	Anodizado	6000mm - DES 994	UN

TRILHO J SIMPLES PARA JANELA

Código	Tamanho	Emb.
9159530000	Barra 4m	UN
9159520003	Barra 6m	UN

TRILHO PANTOGRÁFICO PARA JANELA

Código	Descrição	Emb.
9159520002	Barra 6m	UN

TRILHO PANTOGRÁFICO CÔNCAVO PARA JANELA

Código	Tamanho	Emb.
9159520004	Barra 6m	UN

PERFIL ALUMÍNIO PARA MDF15 - DES 312

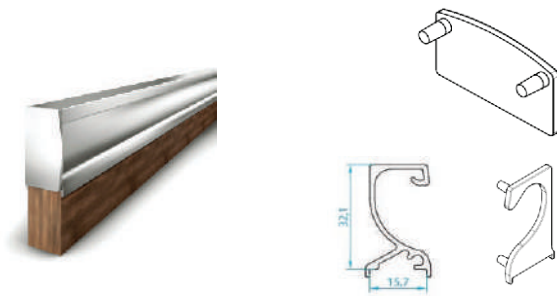

Código	Acabamento	Dimensões	Emb.
6003001947	Anod. fosco	32x6120mm	UN
6003001913	Inox escov.	32x6120mm	UN

*Códigos Perfis

Código	Acabamento	Descrição	Emb.
4144463020	Inox escov.	pont. 15mm - 2 pinos frontal	UN
4144463051	Cromado	pont. 15mm - 2 pinos frontal	UN
4144463070	Fosco	pont. 15mm - 2 pinos frontal	UN
4144493239	Inox	par pont. 15mm - esq/dir vazada 2 pinos	UN
4144493051	Cromado	par pont. 15mm - esq/dir vazada 2 pinos	UN
4144493070	Fosco	par pont. 15mm - esq/dir vazada 2 pinos	UN

*Códigos Ponteiras

PERFIL ALUMÍNIO 37339 MDF15 - DES 621

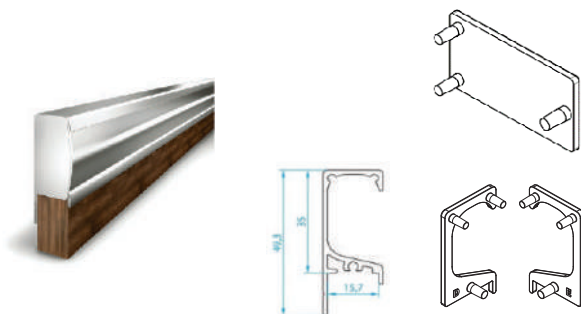

Código	Acabamento	Dimensões	Emb.
9110000036	Anod. fosco	35x6000mm	UN

*Código Perfil

Código	Acabamento	Descrição	Emb.
4144453021	Inox Escov.	pont. 15mm - 3 pinos frontal	UN
4144453051	Cromado	pont. 15mm - 3 pinos frontal	UN
4144453070	Fosco	pont. 15mm - 3 pinos frontal	UN
4144583051	Cromado	par pont. 15mm - esq/dir vazada 3 pinos	UN
4144583070	Fosco	par pont. 15mm - esq/dir vazada 3 pinos	UN
4144583024	Inox	par pont. 15mm - esq/dir vazada 3 pinos	UN

*Códigos Ponteiras

PERFIL ALUMÍNIO PARA MDF18 - DES 197

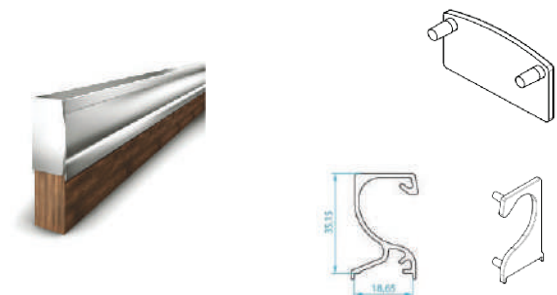

Código	Acabamento	Dimensões	Emb.
6003001949	Inox escov.	35x6000mm	UN
6003001951	Anod. fosco	35x6120mm	UN

*Códigos Perfis

Código	Acabamento	Descrição	Emb.
4144443022	Inox escov.	pont. 18mm - 2 pinos frontal	UN
4144443051	Cromado	pont. 18mm - 2 pinos frontal	UN
4144443070	Fosco	pont. 18mm - 2 pinos frontal	UN
4144423024	Inox	par pont. 18mm - esq/dir vazada 2 pinos	UN
4144423051	Cromado	par pont. 18mm - esq/dir vazada 2 pinos	UN
4144423070	Fosco	par pont. 18mm - esq/dir vazada 2 pinos	UN

*Códigos Ponteiras

PERFIL ALUMÍNIO 37331 MDF18 - DES 620

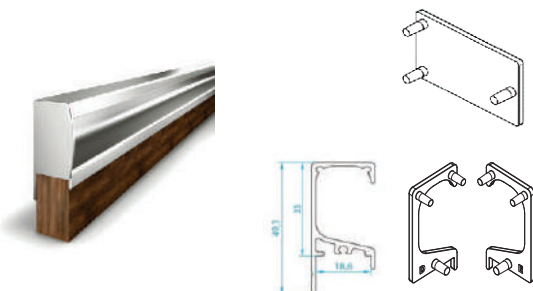

Código	Acabamento	Dimensões	Emb.
9110000035	Anod. fosco	35x6000mm	UN

*Código Perfil

Código	Acabamento	Descrição	Emb.
4144473020	Inox	pont. 18mm - 3 pinos frontal	UN
4144473051	Cromado	pont. 18mm - 3 pinos frontal	UN
4144473070	Fosco	pont. 18mm - 3 pinos frontal	UN
4144563051	Cromado	par pont. 18mm - esq/dir vazada 3 pinos	UN
4144563070	Fosco	par pont. 18mm - esq/dir vazada 3 pinos	UN
4144563024	Inox	par pont. 18mm - esq/dir vazada 3 pinos	UN

*Códigos Ponteiras

PUX. PERFIL ALUMÍNIO JATEADO ANODIZADO

Código	Descrição	Emb.
2001000331	MDF15 / alt. 30x6000mm - DES 339	UN
2001000432	MDF18 / alt. 35x6000mm - DES 009	UN

CANTONEIRA PARA CORTINA

Código	Dimensões	Emb.
3853234240	4x4cm	UN
3853234257	5x5cm	UN
3853230266	6x8cm	UN
3853230082	8x10cm	UN

CANTONEIRA PARA CORTINA LEVE

Código	Dimensões	Emb.	Código	Dimensões	Emb.
3853237012	3x3cm	UN	3853237081	6x9cm	UN
3853237029	4x4cm	UN	3853237067	7x7cm	UN
3853237036	5x5cm	UN	3853237128	7x11cm	UN
3853237074	6x8cm	UN	3853237104	8x10cm	UN

CANTONEIRA PARA PRATELEIRA

Código	Dimensões	Emb.	Código	Dimensões	Emb.
3853034147	4x5	UN	3853034185	8x10	UN
3853034154	5x6	UN	3853035182	8x10	UN
3853034161	6x8	UN	3853035113	10x12	UN
3853035168	6x8	UN	3853034116	10x12	UN





2020



www.grupobigfer.com.br

Siga-nos nas redes sociais! @grupo.bigfer.1 @grupobigfer Grupobigfer

Bigfer Indústria e Comércio
Farroupilha - RS
|54| 2109.2940

Bigfer Curitibaanos
Curitibaanos - SC
|49| 3241.7602

Bigfer Paraná
Curitiba - PR
|41| 3341.4888

Bigfer São Paulo
Votuporanga - SP
|17| 3423.5291